

GEEMARC

CLEAR SOUND™

HEAR THE DIFFERENCE

CL1200

MULTIFUNCTION TELEPHONE



English

CONTENTS

CONTENTS	1
INTRODUCTION	3
Unpacking the Telephone	4
DESCRIPTION	5
General Description	5
INSTALLATION	10
Setting Up	10
Wall Mounting	11
SETTINGS	12
Ringer Settings	12
Flash (Recall) Setting	12
Receiving Voume and Tone Settings	13
Speakerphone Volume Setting	15
Sending Volume Setting	15
USING THE TELEPHONE	16
Making a Call	16
Receiving a Call	17
Last Number Redial	17
Mute Function	17
Hearing Aid Use	18
Flash Signal	18
MEMORY	19
Storing a Number to Memory	19
Dialling a Number from Memory	19

CONTENTS

TROUBLESHOOTING	20
SAFETY INFORMATION	21
GUARANTEE	22
RECYCLING DIRECTIVES	24

INTRODUCTION

Congratulations on purchasing your Geemarc CL1200. This is an amplified big button telephone. The large button keypad is easy to see and use, it helps prevent any misdialling. There are quick dial buttons, also designed to make dialling easier because you will be able to call friends, family and other important people with the ease of one touch dialling. This telephone is compatible with hearing aids.

It is important that you read the instructions below in order to use your Geemarc telephone to its full potential. Keep this user guide in a safe place for future reference.

This guide explains how to use the following telephone:

CL1200



INTRODUCTION

Unpacking the Telephone

When unpacking the telephone, you should find the following in the box:

- 1 CL1200 unit
- 1 CL1200 handset with curly cord
- 1 Telephone line cord
- 1 User Guide



For product support and help visit our website at

www.geemarc.com

Telephone 01707 384438

Or fax 01707 372529

DESCRIPTION

General Description

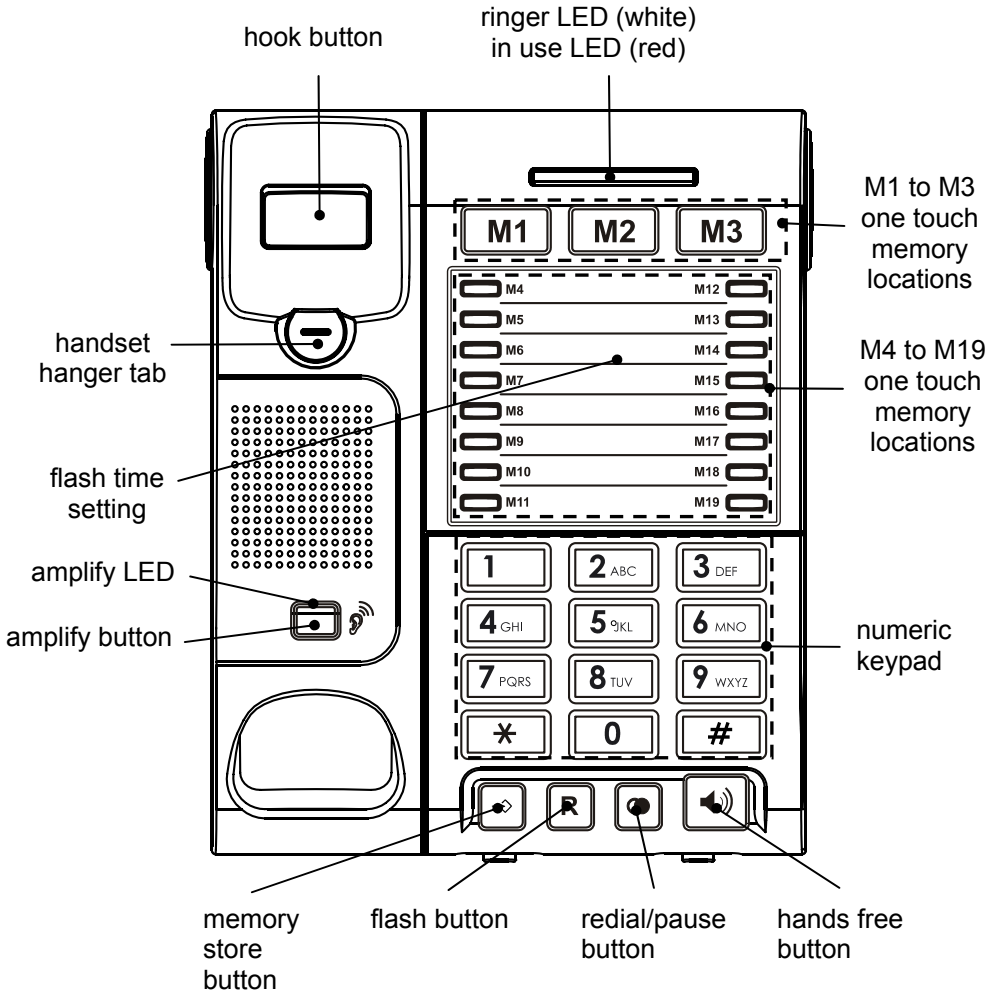

DESCRIPTION

Handset Description

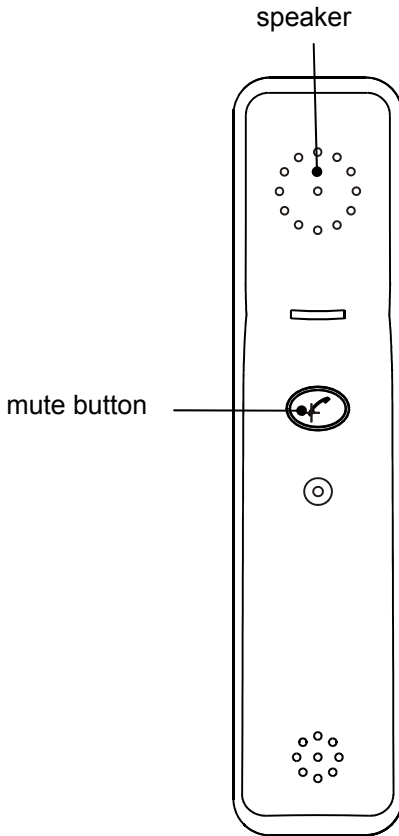

DESCRIPTION

Rear Description

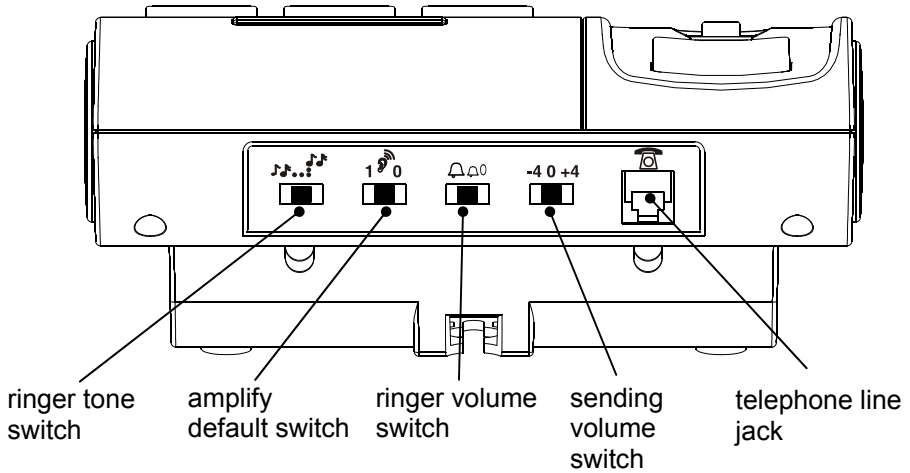

Front Description

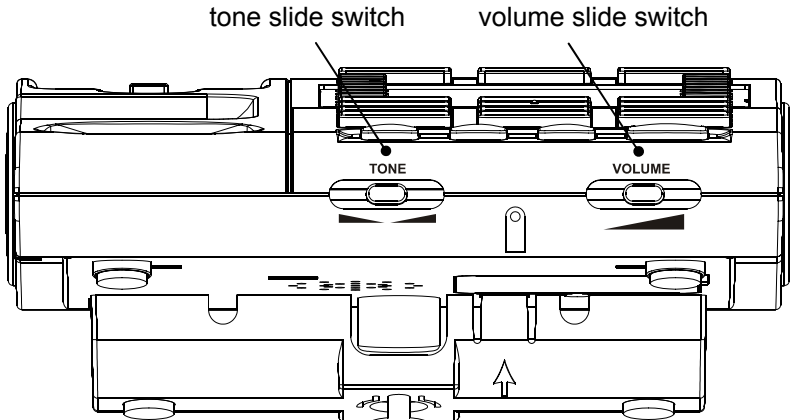

DESCRIPTION

Left Side Description

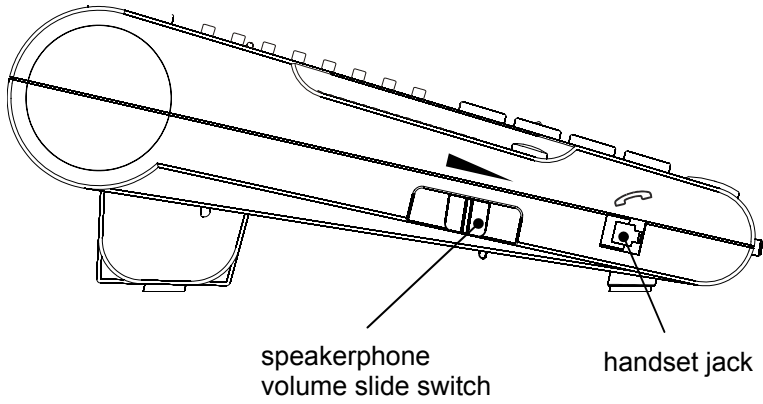

Right Side Description

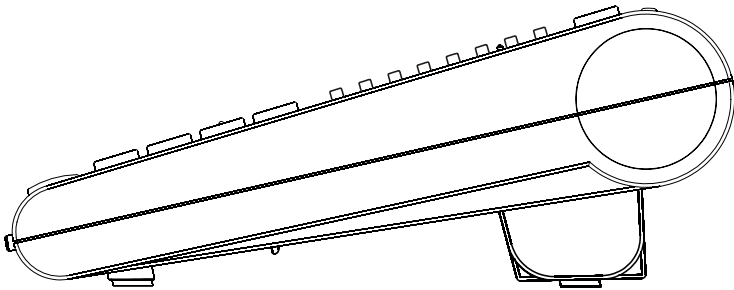

DESCRIPTION

Underside Description

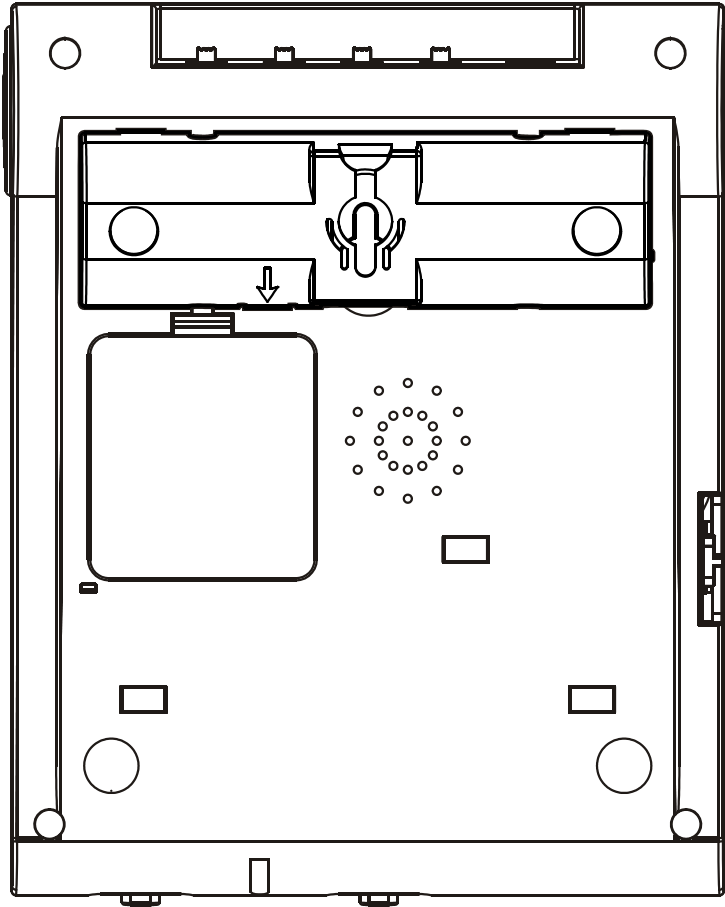

INSTALLATION

Setting Up

Connect the handset to one end of the curly cord. Plug the other end of the curly cord into the jack  on the left hand side of the CL1200 unit. Place the handset on the cradle.

Connect the line cord to the jack  located at the rear of the telephone. Connect the plug at the other end of the line cord into the wall socket *.

Pick up the handset and listen for the dial tone.

(*) Classified TNV-3 according to EN60950 standard

INSTALLATION

Wall Mounting

Turn the handset hanger tab round (rotate it 180 degrees). This will keep the handset from falling out of the cradle when it is mounted on the wall.

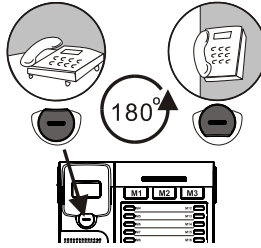

Install two screws at a distance of 83 mm from each other on a vertical line. Leave the screws protruding from the wall by 5mm. Insert the mounting bracket's two tabs into the matching slots opposite the keyhole slot on the underside phone's base. Then press down and slide the bracket upward until the tabs snap into place.

Plug one end of the telephone line cord into the jack  located at the rear of the telephone unit and the other end into the wall plate jack.

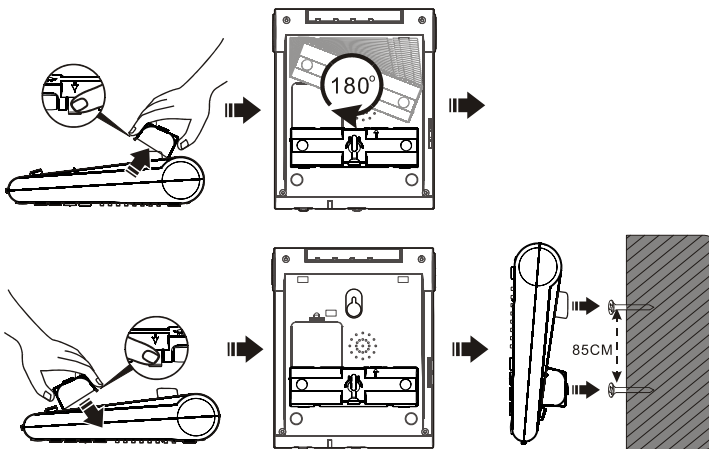

SETTINGS

Ringer Settings

A switch located on the rear of the CL1200 unit  allows the ringer volume to be switched to HI (maximum volume), LOW (lowest volume) or OFF (if you would prefer not to be disturbed).

A switch located on the rear of the CL1200 unit  allows the ringer tone to be selected. There are 3 tones available, HIGH, MID and LOW.

Flash (Recall) Setting

You can adjust the flash time by using the switch located under the protective cover on the top of the telephine unit. There are two levels available, 100ms and 270ms. Your telephone works with a flash time for United Kingdom (R=100ms).

SETTINGS

Receiving Volume and Tone Settings

You can alter the receiving volume and tone during a conversation according to your hearing requirements.

The handset earpiece volume may be adjusted during a call using the volume slide control  found at the front of the telephone base. The volume adjustment available is 0-15dB.

The speakerphone volume is adjusted with the volume slide control  found on the left side of the base.



The  button on the telephone base provides additional amplification of 15dB i.e the volume adjustment will become 15-30B. When the amplify function is activated, the Amplify LED will be lit.



Setting a default for Amplification.



The  switch located at the rear allows the amplification facility to be switched ON or OFF as a default each time you use the telephone. '1' is ON.

SETTINGS

AMPLIFY ON/OFF Switch at ON Position

The additional amplification and tone controls are automatically activated each time you use the telephone. The amplify LED light will be lit when you use the telephone.

Pressing the Amplify button during a call will turn off the additional amplification and tone controls. However, you can still adjust the handset receive volume with the Volume slide bar.

Irrespective of how many times you press the amplify key throughout a call, the next time you pick up the handset to make a new call, these functions will be activated once again.

AMPLIFY ON/OFF Switch at OFF Position

The additional amplification and tone controls are deactivated each time you use the telephone. The Amplify LED will be off whenever you use the telephone.

Pressing the Amplify button once during a call will enable tone control and additional amplification. The LED light will turn on to reflect this change. If you press the amplify button once more, the additional amplification and tone control features will be turned off once again. The LED light will turn off to reflect this change.

Irrespective of how many times you press the amplify key throughout a call, the next time you pick up the handset, these functions will be turned off once again.

SETTINGS

Tone Receiving Adjustment

If the receiver volume has been amplified, the tone control



can also be adjusted. You can adjust and increase the low frequency or high frequency sounds with the tone slide control on the top of the unit.



Note: The tone adjustment function will not be effective when the receiver volume is set to normal level.

Speakerphone Volume Setting

In hands free mode you can adjust the speaker volume by using the volume slide control on the left side of the base.

Sending Volume Setting

If your voice is quiet or called parties have difficulty hearing you, you can increase the sending volume using the - **4 0 + 4** switch found at the rear of the telephone.

USING THE TELEPHONE

Making a Call

Pick up handset. The red LED indicator will light up

When you hear the dialling tone, dial the number on the keypad

To end the call simply replace the handset in the cradle

Making a Call – Hands Free

Press the  button to get a dialling tone. The red LED will light up

Dial the telephone number on the keypad.

To end the call, simply press  again

To activate the Hands Free function during the call, press the  button and replace the handset on the cradle at the same time.

To deactivate the Hands Free function during a call, lift the handset.

Note: When in hands free mode, only one person may talk at a time. The switch-over between speaker and microphone is automatic. This is dependent on the sound level of the incoming call and the microphone respectively. It is therefore essential that there are no loud noises, e.g. music, in the immediate vicinity of the telephone, as this will disrupt the hands free function.

USING THE TELEPHONE

Receiving a Call

When an incoming call is received, the telephone rings and the incoming call LED flashes.

Lift the handset and speak. The red LED indicator will light up

To end the call simply replace the handset in the cradle

Receiving a call – Hands Free

Press  for 1 second to speak hands free. The red LED indicator will light up

To end the call press 

Last Number Redial

Lift the handset or press  for hands free use

Press  to redial the last number dialled.

Mute Function

If you wish, you can speak privately to someone else in the room without your caller overhearing. You will still be able to hear the caller but they cannot hear you during the mute operation.

To switch on the mute mode during a call press and hold the  button – found on the underside of the handset. Your caller will not be able to hear you anymore.

Release the mute  again to resume the conversation with your caller.

USING THE TELEPHONE

Hearing Aid Use

This telephone is hearing aid compatible. Select the T mode on your hearing aid to enable this feature.

Flash Signal

The **R** button can be used with special services such as Call Waiting (if provided by your service provider) or transferring external calls to another extension within a private switchboard. This button acts as an electronic form of a switch hook operation.

MEMORY

Storing a Number to Memory

The CL1200 has 19 one touch memory buttons.

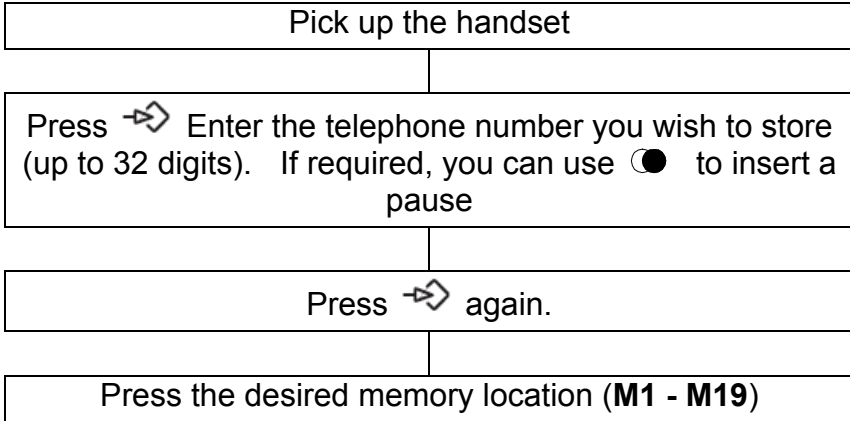

Entering a new number into a memory location which currently stores a number will automatically erase the original number

A memory index card is located on the base so you can record the location of telephone numbers.

Dialling a Number from Memory

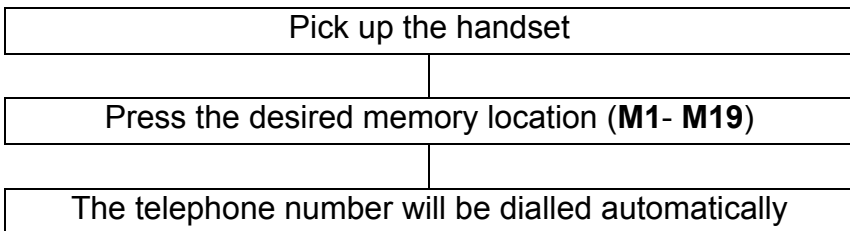

Note: these one touch memories continue to be stored even if the telephone is disconnected.

TROUBLESHOOTING

CL1200 does not ring

- Make sure that the telephone line cord is plugged in correctly and is not damaged
- Connect another telephone to the telephone PTT socket or move your telephone to another socket to track if the failure is coming from your telephone or your PTT socket
- There may be too many communication devices connected to a single telephone line e.g. another telephone, modem or facsimile machine. Contact your network provider for help in calculating the limit for your home or business line
- Make sure the ringer setting is not switched to OFF

No dial tone

- Make sure that the telephone line cord is plugged in correctly and is not damaged
- Connect another telephone to the telephone PTT socket or move your telephone to another socket to track if the failure is coming from your telephone or your PTT socket
- There may be too many communication devices connected to a single telephone line e.g. another telephone, modem or facsimile machine. Contact your network provider for help in calculating the limit for your home or business line

SAFETY INFORMATION

General

Do not open the unit. Contact the helpline for all repairs.

Cleaning

Clean the telephone with a soft cloth. Never use polishes or cleaning agents - they could damage the finish or the electrics inside.

Environmental

Do not expose to direct sunlight.

Always ensure there is a free flow of air over the surfaces of the telephone.

Do not place any part of your product in water and do not use it in damp or humid conditions e.g. bathrooms.

Do not expose your product to fire or other hazardous conditions.

Unplug your phone from the telephone socket during thunderstorms because it could damage your telephone. Your guarantee does not cover thunderstorm damage.

The telephone is designed for working within a temperature range of 5°C to 45°C.

GUARANTEE

From the moment your Geemarc product is purchased, Geemarc guarantee it for the period of one year. During this time, all repairs or replacements (at our discretion) are free of charge. Should you experience a problem then contact our help line or visit our website at www.geemarc.com. The guarantee does not cover accidents, negligence or breakages to any parts. The product must not be tampered with or taken apart by anyone who is not an authorized Geemarc representative. The Geemarc guarantee in no way limits your legal rights.

IMPORTANT: YOUR RECEIPT IS PART OF YOUR GUARANTEE AND MUST BE RETAINED AND PRODUCED IN THE EVENT OF A WARRANTY CLAIM.

Please note: The guarantee applies to the United Kingdom only

DECLARATION: Geemarc Telecom SA hereby declares that this product is in compliance with the essential requirements and other relevant provisions of the Radio and Telecommunications Terminal Equipment Directive 1999/5/EEC and in particular article 3 section 1a, 1b and section 2. The telephone does not operate if the line current is lower than 18 mA.



The declaration of conformity may be consulted at www.geemarc.com

GUARANTEE

Telephone connection: Voltages present on the telecommunication network are classified TNV-3 (Telecommunication Network Voltage) according to the EN60950 standard.

RECYCLING DIRECTIVES

The WEEE (Waste Electrical and Electronic Equipment) has been put in place for the products at the end of their useful life are recycled in the best way.

When this product is finished with, please do not put it in your domestic waste bin.

Please use one of the following disposal options:

- Remove the batteries and deposit them in an appropriate WEEE skip. Deposit the product in an appropriate WEEE skip.

- Or, hand the old product to the retailer. If you purchase a new one, they should accept it.

Thus if you respect these instructions you ensure human health and environmental protection.



For product support and help visit our website at

www.geemarc.com

Telephone 01707 384438

Or fax 01707 372529

UGL1200_En_v1.2



UGCL1200_En_Ver.1.2

geemarc UK

5 Swallow Court
Swallowfields
Welwyn Garden City
Hertfordshire, AL7 1SB
For product support:
01707 384438

www.geemarc.com

geemarc FRANCE

Parc de l'Etoile
2 rue Galilée BP20061
59791 GRANDE SYNTHÉ CEDEX
TEL. SERVICE APRES VENTE:
03 28 58 75 99

www.geemarc.com

geemarc GERMANY

Siemensstrasse 10,
53121 Bonn
Germany
Tel: +49(0)228/ 74 87 09 0
Fax: +49(0)228/ 74 87 09 20

www.geemarc.com