

8180 SIP Audio Alerter (G2) Firmware Version 1.7

User Guide

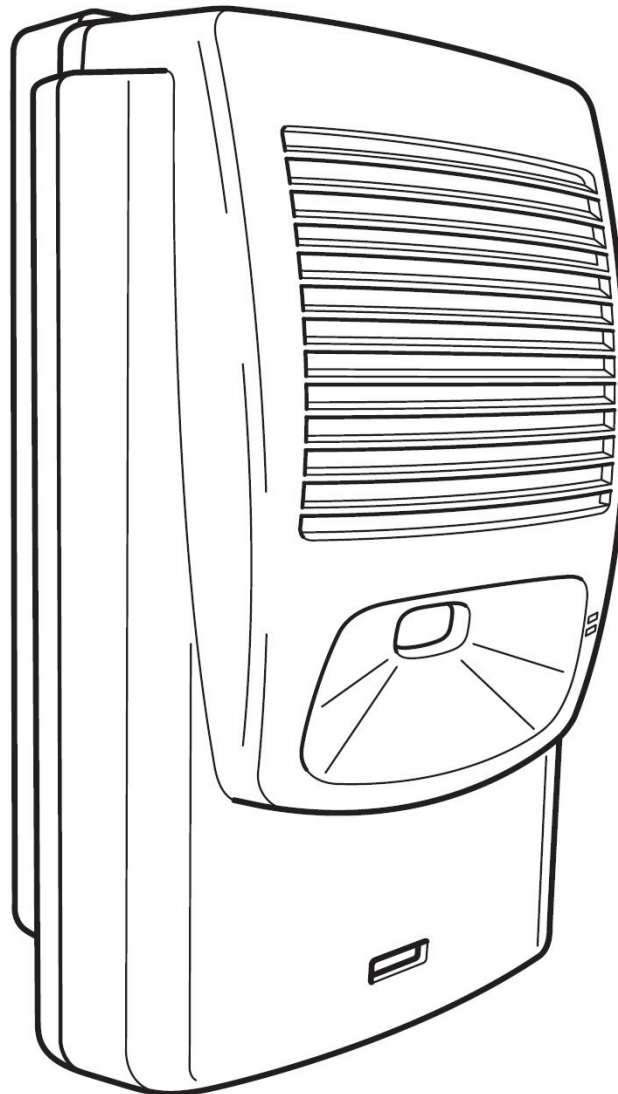

Table of Contents

IMPORTANT SAFETY INFORMATION.....	4
OVERVIEW.....	6
Introduction.....	6
What's New (compared to the original 8180).....	6
Key Features.....	7
Front and Back Views.....	9
Program Buttons.....	9
Soft Reset.....	9
SETUP AND INSTALLATION.....	10
Getting Started - Quick Install & Test.....	10
Wall Mounting.....	11
Input/Outputs.....	11
Programming and Configuration.....	12
FEATURES.....	13
SIP Paging: One 8180.....	13
SIP Ring Event.....	13
Multicast Overview.....	13
SIP Paging: Multiple 8180s (Using Multicast).....	14
SIP Paging: Multiple Speakers (Using Individual SIP extensions).....	15
SIP Activated Notification Alerts.....	15
Background Music Streaming.....	15
Polycom™ Group Paging.....	16
TLS for SIP Signaling and Provisioning.....	16
WEB INTERFACE BASIC SETTINGS.....	20
Web Interface Login.....	20
Status.....	21
Basic Settings Tab – SIP.....	21
Basic Settings Tab – Features.....	23
Basic Settings Tab – Multicast.....	25
Basic Settings Tab – Multicast (Master Settings).....	26
Basic Settings Tab – Multicast (Slave Settings).....	30
WEB INTERFACE ADDITIONAL FEATURES.....	32
Additional Features Tab – Input/Output.....	32
Additional Features Tab – Emergency Alerts.....	38
Additional Features Tab – More Page Extensions.....	39
Additional Features Tab – More Ring Extensions.....	40
WEB INTERFACE ADVANCED SETTINGS.....	41
Advanced Settings Tab – Network.....	41
Advanced Settings Tab – Admin.....	43
Advanced Settings Tab – Time.....	46
Advanced Settings Tab – Provisioning.....	47
Advanced Settings Tab – File Manager.....	49
Advanced Settings Tab – Advanced Audio.....	50
Advanced Settings Tab – Advanced SIP.....	51
Advanced Settings Tab – Advanced Multicast.....	54

WEB INTERFACE SYSTEM.....	56
System Tab – Maintenance.....	56
System Tab – System Log.....	57
WIRING CONNECTIONS.....	58
Network Connection.....	58
Connecting Input Devices.....	58
Terminal Block (Relay Output Mode).....	59
Blue LED Indicator.....	59
SPECIFICATIONS.....	61
DIMENSIONS.....	63
Front and Side.....	63
Wall Bracket.....	64
OPTIONAL 8180 ACCESSORIES.....	64
FCC COMPLIANCE STATEMENT.....	65

Important Safety Information

Important Safety Information

This product is powered by a certified limited power source (LPS), Power over Ethernet (PoE); through CAT5 or CAT6 connection wiring to an IEEE 802.3af compliant network PoE switch. The product is intended for installation indoors. All wiring connections to the product must be in the same building. If the product is installed beyond the building perimeter or used in an inter-building application, the wiring connections must be protected against overvoltage/transient. Algo recommends that this product is installed by a qualified electrician.

If you are unable to understand the English language safety information then please contact Algo by email for assistance before attempting an installation support@algosolutions.com.

Consignes de Sécurité Importantes

Ce produit est alimenté par une source d'alimentation limitée certifiée (alimentation par Ethernet); des câbles de catégorie 5 et 6 joignent un commutateur réseau à alimentation par Ethernet homologué IEEE 802.3af. Le produit est conçu pour être installé à l'intérieur. Tout le câblage rattaché au produit doit se trouver dans le même édifice. Si le produit est installé au-delà du périmètre de l'édifice ou utilisé pour plusieurs édifices, le câblage doit être protégé des surtensions transitoires. Algo recommande qu'un électricien qualifié se charge de l'installation de ce produit.

Si vous ne pouvez comprendre les consignes de sécurité en anglais, veuillez communiquer avec Algo par courriel avant d'entreprendre l'installation au support@algosolutions.com.

Información de Seguridad Importante

Este producto funciona con una fuente de alimentación limitada (Limited Power Source, LPS) certificada, Alimentación a través de Ethernet (Power over Ethernet, PoE); mediante un cable de conexión CAT5 o CAT6 a un conmutador de red con PoE en cumplimiento con IEEE 802.3af. El producto se debe instalar en lugares cerrados. Todas las conexiones cableadas al producto deben estar en el mismo edificio. Si el producto se instala fuera del perímetro del edificio o se utiliza en una aplicación en varios edificios, las conexiones cableadas se deben proteger contra sobretensión o corriente transitoria. Algo recomienda que la instalación de este producto la realice un electricista calificado.

Si usted no puede comprender la información de seguridad en inglés, comuníquese con Algo por correo electrónico para obtener asistencia antes de intentar instalarlo: support@algosolutions.com.

Wichtige Sicherheitsinformationen

Dieses Produkt wird durch eine zertifizierte Stromquelle mit begrenzter Leistung (LPS – Limited Power Source) betrieben. Die Stromversorgung erfolgt über Ethernet (PoE – Power over Ethernet). Dies geschieht durch eine Cat-5-Verbindung oder eine Cat-6-Verbindung zu einer IEEE 802.3af-konformen Ethernet-Netzwerkweiche. Das Produkt wurde konzipiert für die Installation innerhalb eines Gebäudes. Alle Kabelverbindungen zum Produkt müssen im selben Gebäude bestehen. Wenn das Produkt jenseits des Gebäudes oder für mehrere Gebäude genutzt wird, müssen die Kabelverbindungen vor Überspannung und Spannungssprüngen geschützt werden. Algo empfiehlt das Produkt von einem qualifizierten Elektriker installieren zu lassen.

Sollten Sie die englischen Sicherheitsinformationen nicht verstehen, kontaktieren Sie bitte Algo per Email bevor Sie mit der Installation beginnen, um Unterstützung zu erhalten.

Algo kann unter der folgenden E-Mail-Adresse erreicht werden:

support@algosolutions.com.

安全须知

本产品由认证的受限电源（LPS），以太网供电（PoE），通过 CAT5 或 CAT6 线路联接至 IEEE 802.3af 兼容的 PoE 网络交换机供电。本产品适用于室内或建筑物周边安装。所有联接本产品的线路必须源自同一建筑物。本产品如需用于超出建筑物周边范围或跨建筑物的安装，线路联接部分必须有过压和瞬态保护。Algo 建议本产品由专业电工安装。

如果您对理解英文版安全须知有问题，安装前请通过电子邮件和 Algo 联系，support@algosolutions.com。

EMERGENCY COMMUNICATION

If used in an emergency communication application, the 8180 SIP Audio Alerter (G2) should be routinely tested. SNMP supervision is recommended for assurance of proper operation. Contact Algo for other methods of operational assurance.

DRY INDOOR LOCATION ONLY

The 8180 SIP Audio Alerter (G2) is intended for dry indoor locations only. For outdoor locations Algo offers weatherproof speakers and strobe lights.

CAT5 or CAT6 connection wiring to an IEEE 802.3af compliant network PoE switch must not leave the building perimeter without adequate lightning protection.

No wiring connected to the 8188 SIP Ceiling Speaker may leave the building perimeter without adequate lightning protection.

Overview

Introduction

The 8180 SIP Audio Alerter (G2) is a SIP-compliant & multicast capable IP speaker for loud ringing, alerting, and voice paging. The 8180 can be integrated with any Communication Server (hosted/cloud or premise) that supports 3rd party SIP endpoints or multicast.

For loud ringing, the 8180 is assigned a Ring extension. When this SIP extension is called the 8180 will play a WAV file (tone, announcement, etc.) over the speaker. Several ringtones are included in the 8180 and custom WAV files may also be uploaded (e.g. safety, security, emergency alerts). For extra volume, or in noisy or wet locations, the optional 1186 Horn Speaker can be used and connected to the 8180 Speaker Output (or the single-piece Algo 8186 SIP Horn can be used instead of this pair of products, if an Ethernet cable is available at the desired horn location).

For voice paging, a separate Page extension can be assigned. When this SIP extension is called, the 8180 will auto-answer and play the caller's voice announcement over the speaker. The 8180 supports G.722 wideband HD Voice for enhanced intelligibility and clarity.

A multicast feature allows one 8180 to broadcast page or ring audio to multiple Slave 8180 endpoints. Multicasting allows for a scalable and cost-effective means of designing large scale paging and alerting solutions, with minimal network traffic and as few as one SIP extension for the registered Master endpoint sending the multicast. Any number and combination of Algo IP speakers, paging adapters and strobe lights can be part of an RTP multicast. Polycom Group Page and SA Announce are other multicast formats supported in the 8180 and related Algo endpoints. InformaCast support is also available with an additional license purchase.

The 8180 is configured using central provisioning features, or by accessing a web interface using browsers such as Google Chrome, Firefox, or Internet Explorer.

What's New (compared to the original 8180)

The 8180 SIP Audio Alerter (G2) is the next generation of the popular Algo 8180. The speaker has upgraded hardware capable of running the latest security and encryption standards, including TLS & SRTP, ensuring secure communication with hosted SIP providers.

Designed to include all the features of the original 8180, the second generation has a number of new features such as enhanced multicast options, dedicated 'Emergency Alert' Extensions, and more.

As this device now runs on a new hardware platform, note that the firmware files are different compared to the original 8180. For assistance migrating provisioning files for this new device, please contact Algo support.

Key Features

SIP Extensions

The 8180 connects to an on-premise or hosted communication server in the same way as a SIP telephone. To register the 8180 with the server requires the following information:

1. IP address (e.g. 192.168.1.1) or domain name (e.g. myserver.com) of the SIP Server
2. SIP extension (e.g. 3790)
3. Authentication ID
4. Password

The 8180 supports two SIP extensions which behave differently – **RING** and **PAGE**. One or both may be used depending on the application. If the RING extension is called the 8180 will not answer. Instead, it will play the selected WAV file until the ringing stops. Typically the RING extension is programmed as part of a hunt group so that it receives a ring signal simultaneously with one or more phones to function as a loud ringer in noisy or large areas.

If the PAGE extension is called, the 8180 will answer and allow paging over its internal speaker. When the 8180 answers it will play a configurable tone to the caller so they know when they can begin speaking. The same tone is also played over the speaker before the announcement. If Paging to a single 8180, talkback may be enabled using the integrated microphone. The audio direction is determined by the speech activity of the caller.

Loudness

Equipped with a high-efficiency integrated amplifier and tuned high-quality loudspeaker, the 8180 is typically eight times louder than a telephone speaker. If the optional Algo Horn Speaker is used, then the 8180 can be 20 times louder.

Multicasting

Allows multiple units to simultaneously play Ring or Page audio. One 8180 may be configured as a 'Master' device and broadcast an audio stream to any number/combination of Algo IP speaker, paging adapter, or strobe endpoint configured as multicast 'Slaves'. This feature provides scalability without requiring each endpoint Slave to be registered with a SIP extension.

Polycom™ Group Paging

The 8180 support Polycom Group Paging. The 8180 can be added to a Polycom Group Page so that voice paging is heard over Polycom telephone speakers and overhead paging simultaneously.

Ambient Noise Compensation

The 8180's can automatically adjust loud ring and paging volume to compensate for background ambient noise. If 'Ambient Noise Compensation' is enabled, the alert volume

will get louder or quieter by the same dB level as the ambient noise measured just prior to the alert.

Configuration & Provisioning

Configuration can be done through a web interface control panel or by using the program buttons on the back of the unit. Central provisioning may also be used to allow units to be pre-configured for a specific server prior to deployment in the field. Configuration files are automatically downloaded from a server (via TFTP, FTP, HTTP, HTTPS) using DHCP.

Input/Outputs for External Equipment and Devices

The 8180 has a speaker output, an audio output, and dry contact relay that can be set as input or output. The outputs can be paired with an external speaker, a slave amplifier, or a visual Alerter (Algo 1127) to enhance notification and alert capabilities. The dry contact relay can be prompted by any normally open, normally closed switch, Algo 1202 Call Button, Algo 1203 Call Switch, or Algo 1204 Volume Control Switch.



Note: The internal speaker is disabled when an external speaker is used.

Blue Indicator Light

This LED light is on during initialization, boot, or while active. Ring and Page modes, when active, will turn the LED on steady. If the optional talkback mode is enabled, the LED will flash instead (during a page event) to provide a clear indication that the microphone is active. The LED heartbeat option, when enabled, will flash the LED every 30 seconds as visual confirmation of PoE power and SIP server registration.

Front and Back Views

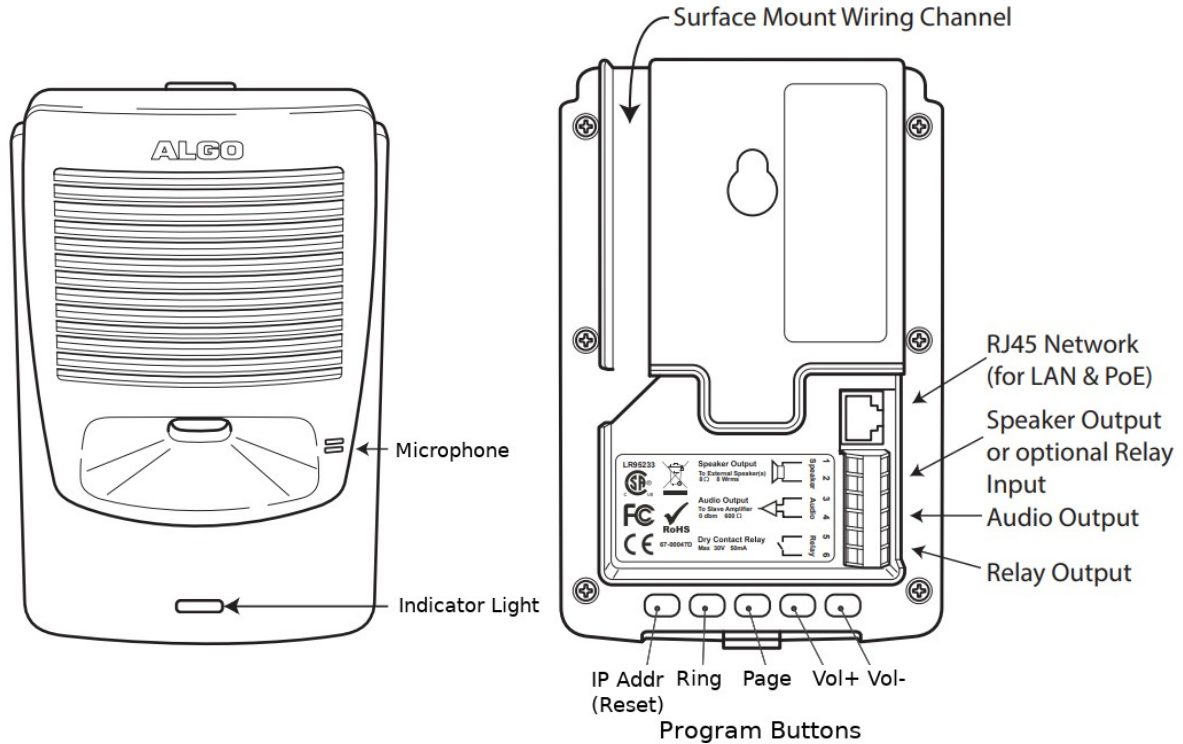

Program Buttons

The Program buttons on the back of the 8180 allow for local adjustment of alert tones and alert volume. The buttons are intentionally hidden from view after installation.



IP Addr (Reset) button plays the IP Address of the device and acts as a soft reset. The **Ring** button plays the current ring tone and allows volume adjustments using the **Vol+** and **Vol-** buttons. Similarly, the **Page** button plays an audio file at the current page volume and allows volume adjustments using the **Vol+** and **Vol-** buttons.

Soft Reset

A soft reset will restore all device settings back to the original factory default conditions. To perform a soft reset, disconnect and connect the network cable, ensuring that there is power to the device. Once the LED starts to flash, hold down the **IP Addr (Reset)** button until the LED light starts to flicker at a faster rate, then release. When the speaker plays a tone, the reset is complete.

Setup and Installation

Getting Started - Quick Install & Test



This guide provides important safety information which should be read thoroughly before permanently installing the speaker.

1. Connect the 8180 SIP Audio Alerter (G2) to an IEEE 802.3af compliant PoE network switch. The blue light will remain on until boot up is completed – about 30 seconds.
2. After the blue LED turns off and you hear a tone, press the 'IP Addr' button on the back of the unit to hear the IP address over the speaker. The IP address may also be discovered by downloading the Algo Locator Tool to find Algo devices on your network: www.algosolutions.com/locator
3. Mount the speaker. Summarized instructions are provided in the next section of this sheet.
4. Access the 8180 web page by entering the IP address into a browser (Chrome, IE, Firefox etc.) and login using the default password: **algo**
5. Enter the IP address for the SIP server into the SIP Domain field under the **Basic Settings > SIP** tab.
6. Enter the Ring and/or Page SIP extension and credentials. Leave the credentials blank for either extension if there is no intended use to have both registered.

(Note: The speaker supports multiple Ring, Emergency Alert, and Page SIP extensions. The Page extension auto-answers for voice announcements. The Ring and Emergency Alert extensions will play a WAV file over the speaker without answering.)
7. Make a test call from a telephone to the speaker for one or both extensions. The Page SIP extension should auto-answer, play the default pre-announce WAV file, and open a speech path to make a voice announcement. The Ring SIP extension will play the default WAV file from those available in device memory.

Wall Mounting

Mount the wall bracket securely and snap the 8180 into the bracket by engaging the top and then pushing the bottom firmly into place. To remove the 8180 from the bracket, press firmly on the tab of the bottom catch, then lift the cover

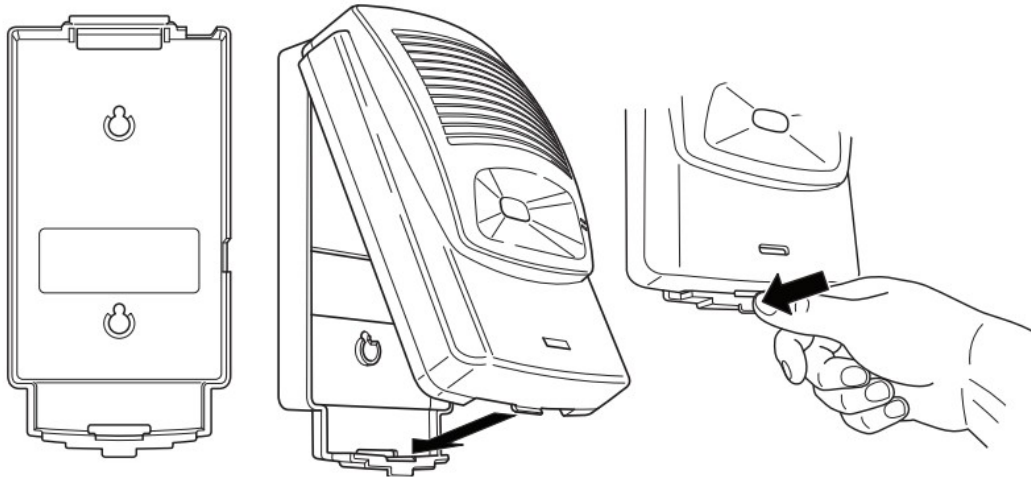

Input/Outputs

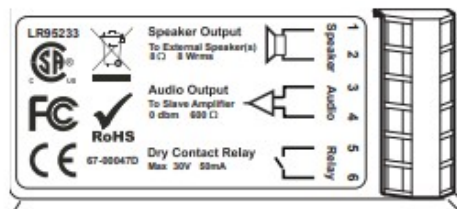

Relay

The dry contact relay can be configured as an input or output relay. When the relay is configured as an 'Output', it can be enabled for ring/paging to activate a visual alerter, mute background music, or enable a slave amplifier. When the relay is configured as an 'Input', it can be prompted by any normally open, normally closed switch to play a tone, make a SIP voice call, make a SIP call with tone, or stream mic audio.

Auxiliary Speaker

For connection to the optional Algo horn speaker (e.g. for outdoor/wet locations) or to ceiling speakers wired in a series-parallel configuration to maintain minimum 8 Ω. The presence of an external speaker(s) will automatically disable the internal speaker to preserve power.

Audio

High impedance output for driving 600 Ω load up to 0 dBm. Internal speaker may be active simultaneously, but levels cannot be adjusted separately.

Programming and Configuration

After connecting the 8180 to a network PoE, the blue indicator light will turn on during initialization. The 8180 will then attempt to obtain an IP address from the DHCP server. If there is no DHCP server or the attempt was unsuccessful, the 8180 will default to the static IP address **192.168.1.111**.



Note: If you don't have a PoE switch, you'll need a PoE injector that installs between the 8180 and network switch. The PoE injector will supply 48 Vdc to the 8180. Most PoE injectors are capable of providing more power than the 8180 requires (12.95 W). Ensure that the PoE injector is fully compliant to the IEEE 802.3af standard.

After a successful boot up the blue LED will turn off and you will hear a tone, and the speaker will have obtained an IP address.

Press the '**IP Addr (Reset) Button**' (next to the Ring Button) momentarily to hear the IP address over the speaker and press it again to stop playing the IP address over the speaker.

The IP address may also be discovered by downloading the Algo locator tool to find Algo devices on your network: www.algosolutions.com/locator

Enter the IP address (e.g. 192.168.1.111) into a browser such as Google Chrome, Firefox, or Internet Explorer (other than IE9). The web interface should be visible and the default password will be **algo** in lower case letters.

Features

SIP Paging: One 8180

The 8180 SIP speaker can be registered as a third-party SIP extension with a hosted or enterprise Communications Server supporting 3rd party SIP endpoints.

To register the speaker with the SIP server, use the **Basic Settings > SIP** tab in the web interface to enter the Communication Server IP address, extension, username, and password. This information will be available from the IT Administrator.

If VLAN is used, navigate to the **Advanced Settings > Network** tab to set VLAN options.



Important: once the speaker is using VLAN you will need to be on the same VLAN to access the web interface.

The speaker may now be accessed by dialing its assigned extension from a telephone, device, or client. The speaker will auto-answer, play the default WAV pre-announce tone, and allow voice paging until disconnected.

There are a number of configurable speaker options:

- Increase or Decrease Speaker Volume
- Enable AGC (automatic gain control)
- Enable Ambient Noise Monitoring (speaker volume adapts to background noise)
- Enable Talkback
- Customize pre-announce tone WAV file

The best voice paging quality and intelligibility will be obtained using the G.722 wide-band audio codec. Most current IP telephones support G.722 which is sometimes referred to as “HD” voice or audio.

SIP Ring Event

Set Monitoring Mode to **'Monitor Ring'** and enter credentials. When a call is made to the SIP extension the 8180 will play the selected WAV file from memory. Often, the 8180 will be part of a hunt group or ring group to ring in conjunction with a telephone.

Multicast Overview

In addition to the ring and page features, the 8180 is able to send and receive IP audio multicast messages over the network to support larger deployment for both paging and ring/notification. This provides a scalable and efficient method of building large scale notification solutions.



In the diagram above, the bottom 8180 is configured with a SIP Page Extension. When called from a phone, the SIP registered 8180 auto-answers and plays the page audio over its speaker. Simultaneously, the registered 8180 endpoint broadcasts the audio over the network using RTP multicast to any number/combination of Algo IP speakers, paging adapters, and strobes as required.

The registered 8180 (i.e. bottom of illustration) is configured as multicast **Master** and the top 3 endpoints are multicast **Slaves**. The Slave endpoints require a PoE network connection but do not require registration to the communication server.

Multicasting can also be used to distribute loud ring or other alerting (e.g. safety, security, or emergency events) over multiple Algo endpoints (e.g. 8180, 8186, 8188, 8128, 8201, 8301, and 8373).

SIP Paging: Multiple 8180s (Using Multicast)

Multicast features in the 8180 SIP speaker require that only ONE of the speakers be registered with a SIP extension. Additional speakers may be added as multicast Slaves receiving a stream from the SIP registered Master speaker. Please note that any number and combination of Algo speakers, paging adapters and strobes can be part of a multicast zone.

The Master speaker will page normally while simultaneously streaming audio to the slave speakers. The Slave speakers do not require SIP extensions and do not need to register with the SIP Communication Server.

To enable multicast streaming from the SIP speaker, go to its web interface and navigate to the **Basic Settings > Multicast** tab. Choose multicast mode '**Master/Sender**' and zone '**All Call**'. The multicast addresses pre-populated in the table, under **Advanced Settings > Advanced Multicast** section, will work in most cases and should only be altered for rare cases.

To enable multicast monitoring in the other speakers, go to the web interface for each speaker and again navigate to the **Basic Settings > Multicast** tab. This time though, choose multicast mode **'Slave/Receiver'** There is no need to select a zone as the speaker will automatically monitor the **'All Call'** zone IP address.

The page pre-announce tone is generated from the Master. The following options are valid for each multicast Slave speaker:

- Increase or Decrease Speaker Volume
- Enable Ambient Noise Monitoring (speaker volume adapts to background noise)

Talkback can only be used for the SIP registered Master speaker. When paging with talkback enabled, only the area near the Master speaker is covered for talkback. The microphones in the multicast Slave speakers are disabled except for ambient noise monitoring.



*Note: See **"Basic Setting Tab – Multicast"** section below for more configuration options and instructions.*

SIP Paging: Multiple Speakers (Using Individual SIP extensions)

In some cases, it may be desirable for every speaker to have a SIP extension. Multicast may still be used to page multiple speakers but each speaker can also be called individually or generate a call when appropriately configured.

A speaker configured as a SIP Multicast Slave will give its highest priority to the 'Priority Call' zone. Other than the 'Priority Call' zone, a page using its SIP extension, has priority over all other multicast zones.

Communication Servers with the capability of dialing many SIP extensions simultaneously for paging may be able to create zones by calling "page groups" and also page telephone speakers in conjunction with overhead speakers.

SIP Activated Notification Alerts

In addition to voice paging, the 8180 SIP Audio Alerter (G2) can play audio files for emergency, safety, and security announcements, customer service, shift changes, etc.

Audio WAV files can be stored in speaker memory and played over the speaker in response to an event such as a ring or relay input, and also multicast to other Algo SIP endpoints on the network. See **Additional Features > Emergency Alerts** and **Additional Features > Input/Output** for more details.

Background Music Streaming

The 8301 Paging Adapter & Scheduler (sold separately), set as a Multicast master, can stream background music to other Algo slave devices on the network from a music source connected to the 8301's AUX Input.

When multicasting music, ensure that Automatic Gain Control (AGC) is 'Disabled' in **Basic Settings > Features** tab on all the slave devices. Meanwhile, on the Multicast master device, select 'G.722' for the 'Master Output Codec' setting in **Advanced Settings > Advanced Multicast** tab.

Polycom™ Group Paging

The 8180 SIP Audio Alerter (G2) has been designed to support Polycom Group Paging. The 8180 can be added to a Polycom Group Page so that voice paging is heard over Polycom telephone speakers and overhead paging simultaneously.

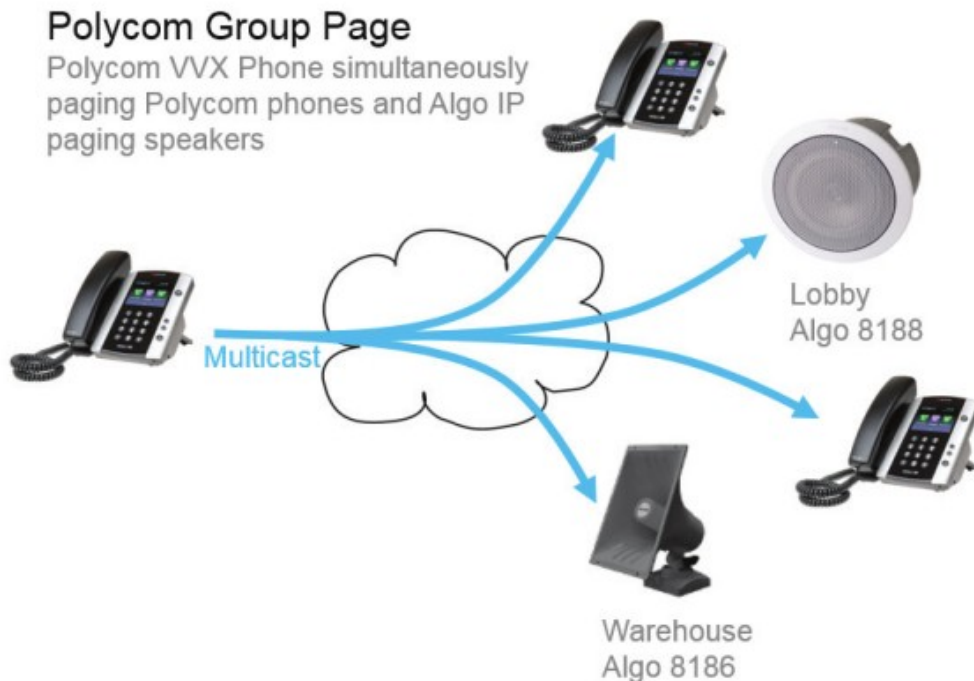

The 8180 SIP Audio Alerter (G2) may be accessed remotely via SIP and may generate a multicast page within the LAN sending voice page to both Algo paging speakers and Polycom telephones. Audio delay may be added to the 8180 to synchronize with voice page over the Polycom telephone speakers

TLS for SIP Signaling and Provisioning

Algo devices that support firmware 1.6.4 or later support Transport Layer Security (TLS). This feature adds security by ensuring that Algo products can trust the hosted SIP server. This is useful for when third-party devices or attackers may try to intercept, replicate, or alter Algo products, and try to connect to the server. TLS protocol will ensure that third parties cannot read/modify any actual data. Previously security was less of a concern because phone systems were on isolated networks, but hosted services are becoming

increasingly more common. Using a hosted SIP service requires traffic to be sent over the public internet and thus much more susceptible to attacks. Signed certificates are an important piece in the Algo device's operation, to ensure the security, integrity, and privacy of its communication. Algo components that use TLS are **Provisioning** and **SIP Signaling**.

These Algo devices each come pre-loaded with certificates from a list of trusted certificate authorities (CA), which are installed in the hardware at the time of manufacture. Note these pre-installed trusted certificates are not visible to users and are separate from the 'certs' folder.

The TLS handshake happens to make sure that the client and server can trust each other, and once that trust is established, the two parties can freely send encrypted data and decrypt any data that they receive. After the TLS handshake process is complete, a TLS session is established, and the server and client can then exchange messages that are symmetrically encrypted with shared (pre-master) secret key.

Provisioning

Provisioning is secured by setting the 'Download Method' to 'HTTPS' (under the **Advanced Settings > Provisioning** tab)

The screenshot shows the 'Provisioning Settings' page in the Algo device web interface. The page has a navigation bar at the top with tabs for 'Status', 'Basic Settings', 'Additional Features', 'Advanced Settings', 'System', and 'Logout'. Below the navigation bar, there are sub-tabs for 'Network', 'Admin', 'Time', 'Provisioning', 'Tones', 'File Manager', 'Advanced Audio', 'Advanced SIP', and 'Advanced Multicast'. The 'Provisioning' sub-tab is selected.

The main content area is titled 'Provisioning Settings' and contains the following sections:

- Mode:** A section with a 'Provisioning Mode' field containing radio buttons for 'Enabled' (selected) and 'Disabled'.
- Settings:** A section containing several fields:
 - Server Method:** Radio buttons for 'Auto (DHCP Option 66/160/150)' (selected), 'DHCP Option 66 only', 'DHCP Option 160 only', 'DHCP Option 150 only', and 'Static'. A help icon and text below state: 'Auto mode automatically checks all 3 DHCP options for an active provisioning server, in the order listed.'
 - Download Method:** Radio buttons for 'TFTP', 'FTP', 'HTTP', and 'HTTPS' (selected).
 - Validate Server Certificate:** Radio buttons for 'Enabled' and 'Disabled' (selected).
 - Auth User Name:** A text input field.
 - Auth Password:** A text input field with a 'Show/Hide' icon.
 - Config Download Path:** A text input field.
 - Firmware Download Path:** A text input field.
- Partial Provisioning:** Radio buttons for 'Enabled' and 'Disabled' (selected). A help icon and text below state: 'Allow support for "-i" incremental provisioning files. Disable for enhanced security if not using this feature.'

A 'Save' button with a green checkmark is located at the bottom right of the page.

Setting provisioning to 'HTTPS' prevents configuration files from being read by unwanted third-party devices/ attackers. This resolves the potential risk of having sensitive data: admin passwords and SIP credentials stolen.

! *Important: To verify the server you must 'Enable' the 'Validate Server Certificate' option. This then checks if the certificate that is provided by the server is signed by any of the CAs included in the list of trusted CAs (used by the Debian infrastructure and Mozilla browsers). If we receive a certificate signed by any of these CAs, then that server will be trusted. Certificates can also be manually uploaded using the 'File Manager'.*

The 'Validate Server Certificate' parameter can also be enabled through provisioning:

```
prov.download.cert = 1
```

SIP Signaling

SIP Signaling is secured by setting 'SIP Transportation' to 'TLS' (under the **Advanced Settings >Advanced SIP** tab)

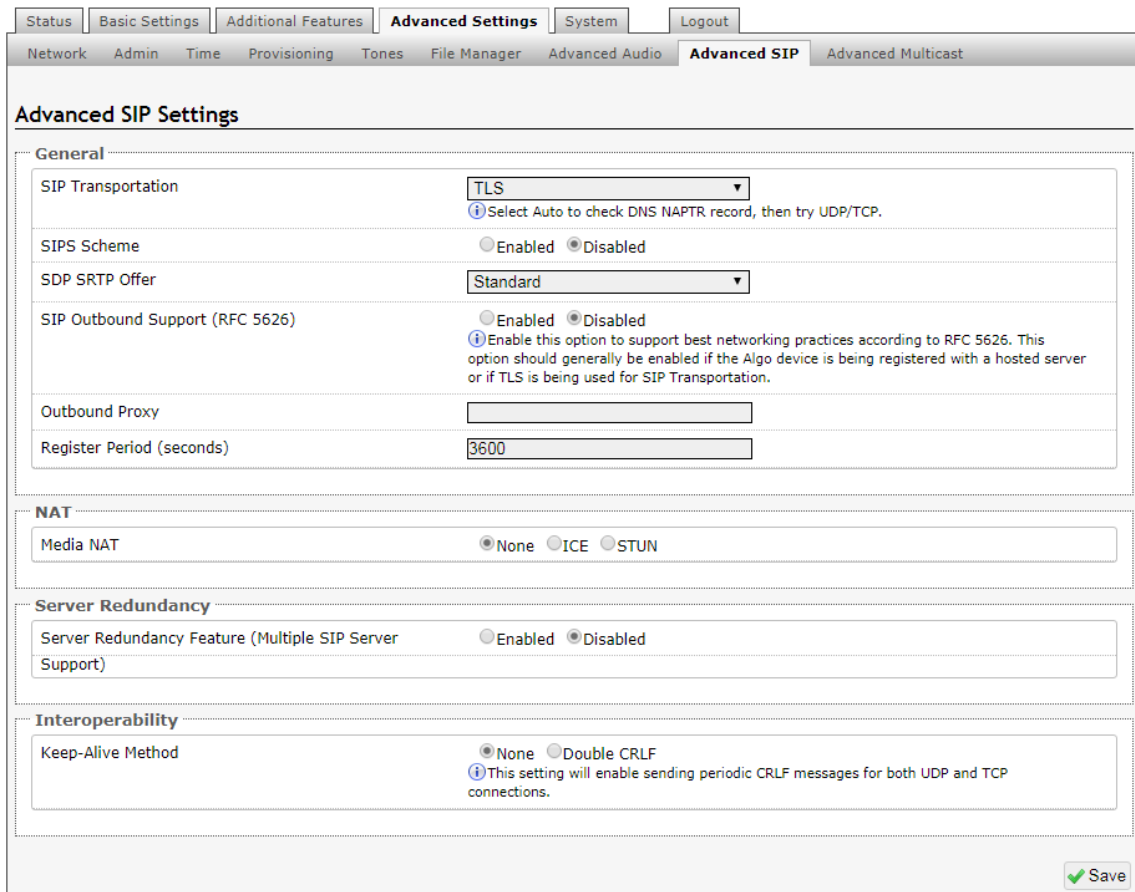

Setting 'SIP Transportation' from 'Auto' (default) to 'TLS', ensures the encryption of SIP traffic. Setting 'SDP SRTP Offer' to 'Standard' or 'Optional', means the SIP call's RTP data will be left unencrypted if the other party does not support SRTP. Setting 'SDP SRTP Offer' to 'Standard', encrypts RTP voice data, meaning the normal audio RTP packets will now be secure (SRTP). This means SIP calls will be rejected if other party does not

support SRTP. The 'Standard' option secures the audio data between parties, by making sure that it's not left out in the open for third parties to later reconstruct and listen to.



Important: In order for a SIP server to validate the Algo device, an additional certificate has to be installed on the Algo device manually. For Firmware v1.7, the only way to add this user certificate file is to use a '.pem' filetype extension and have the file named 'sipclient'. This is done by manually adding a file named 'sipclient.pem', which contains a device certificate and private key, to the 'certs' folder (under the 'Advanced Settings' tab File Manager). In the future, '.crt', '.cer', and '.der' certificate extensions will also be supported and you will not be restricted to naming the file 'sipclient.pem'.

Web Interface Basic Settings

Web Interface Login

The web interface requires a password which is 'algo' by default. This password can be changed in the **Admin** tab after logging in the first time.

Welcome to the Algo 8180G2 SIP Audio Alerter Control Panel

Setting up your SIP Audio Alerter:

Step 1: Configure your SIP Audio Alerter
Log in with the default password and use the Basic Settings pages to set up the basic information.

Step 2: Check network settings (Optional)
Use the Network page under the Advanced Settings tab to change network settings. The default setting for the device is to obtain its IP address from a DHCP server. Contact your Network System administrator if you plan to assign a static IP address, Mask, and Gateway to the device.

Step 3: Secure your SIP Audio Alerter (Optional)
Use the Admin page under the Advanced Settings tab to change the administrator password.
⚠️ Changing the password is extremely important if the device is directly connected to a public network.

Step 4: Register your SIP Audio Alerter (Optional)
Please register your product using the link below:
<http://www.algosolutions.com/register>
Registration ensures your access to the latest upgrades to this product and important service notices.

Login

Password (default: **algo**)

Status

Device Name	sipalerter	
SIP Registration	Page	No Account
Call Status	Idle	
Proxy Status	Single proxy mode	
Security	TLS	Disabled
	SRTP	Disabled
Provisioning Status	None Found	
MAC	00:22:ee:12:00:6e	
IP	10.30.25.5	
Netmask	255.0.0.0	
Gateway	10.0.0.1	
Date / Time	Mon Oct 22 16:26:29 UTC 2018	
Multicast Mode	Disabled	
Volume	Page Volume: 4 (-18dB), Ring Volume: 4 (-18dB)	
Relay Input Status	Disabled	

 *Web Interface is accessed by entering 8180's IP Address into the web browse.*

 *Important: It is highly recommended to change the default password if the device is directly connected to a public network.*

Status

The device's Status page will be available before and after log on. The section can be used to check 8180's SIP Registration status of the Ring/Page extensions, Call Status, Multicast Mode (Slave/Master), Relay Input Status, Proxy Status, and general MAC, IP, Netmask, Date/Time, and Timezone information.



*The Status page can be hidden when logged out for security purposes under the **Advanced Settings > Admin** tab.*

Basic Settings Tab – SIP

SIP Server information and Credentials should be obtained from your telephone system administrator or hosted account provider. After saving the settings, see the Status page to confirm that the registration was successful.

SIP Settings

SIP

This section allows the SIP server information & account credentials to be entered. This information should be obtained from your telephone system administrator or hosted account provider. After saving these settings, see the [Status](#) tab to confirm successful registration.

SIP Domain (Proxy Server) Default port is 5060. To specify a different port, enter PROXY:PORT, e.g. my_proxy.com:5070, or 192.168.1.10:5080.

Ring/Alert Mode

- Monitor "Ring" event on registered SIP extension
- Use "Subscribe/Notify" dialog event (RFC 4235) to monitor event on different extension
- Use "Subscribe/Notify" presence event (RFC 3856/3863 PIDs) to monitor event on different extension
- None

Ring/Alert Extension

Authentication ID

Authentication Password

The device will detect inbound ring events on this extension and play the alerting tone (and multicast if configured) until the inbound call stops ringing. It will not answer the call on this extension.

Base/Page Extension

Authentication ID

Authentication Password

The device will auto-answer any inbound call received on this extension and provide a voice paging path (and multicast if configured).



*Important: Any time changes are made to settings in the web interface the **'Save'** button must be clicked to save the changes.*

SIP Domain (Proxy Server)

The IP address (e.g. 192.168.1.1) or domain name (e.g. myserver.com) of the SIP Server

Ring/Alert Mode

Option for enabling/disabling/or subscribing to a Ring/Alert SIP extension. If activated, screen expands to enter SIP extension parameters for a Ring/Alert Extension.

The device will detect inbound ring events on this extension and play the alerting tone (and multicast if configured) until the inbound call stops ringing. It will not answer the call on this extension.

Subscribe Notify

Can subscribe to and notify, for when a Ring Extension is dialed ('Ring') and/or when the Ring is answered ('Both Ring & In-Use' or 'In-Use').

You must first configure a 'Page Extension', and then can configure a 'Ring/Alert Extension' to subscribe to.

You can subscribe to just the 'Ring' Alert Event, for which when the ring extension is called, the 8180 will also play that ring over its speaker. You can subscribe to just an 'In-Use' Alert Event as well, for which when the ring extension is called, the 8180 will only play that ring over its speaker once the ring is actually answered. Lastly, you can subscribe to both Alert Events by using 'Both Ring & In-Use', for which the 8180 will play the ring over its speaker, when the subscribed ring extension, is being called and when its in-use.

Ring Extension

This is the SIP extension for the 8180 speaker's Ring parameter. The device will detect inbound ring events on this extension and play the alerting tone (and multicast if required) until the inbound call stops ringing. It will not answer the call on this extension.

Page Extension

This is the SIP extension for the 8180 speaker. The device will auto-answer any inbound call received on this extension and provide a voice paging path (and multicast if configured).

Authentication ID

May also be called Username for some SIP servers and in some cases may be the same as the SIP extension used for the associated Ring and/or Page parameter.

Authentication Password

SIP password provided by the system administrator for the SIP account used for the associated Ring and/or Page parameter.

Basic Settings Tab – Features

Status
Basic Settings
Additional Features
Advanced Settings
System
Logout

SIP
Features
Multicast

Features

Inbound Ring Settings

ⓘ These settings apply to events triggered by the Ring Extension(s) & Emergency Alerts sections. The Play/Loop/Stop buttons can also be used to test the device and set the appropriate volume level.

Ring/Alert Tone	warble2-med.wav	Play Loop Stop
Ring/Alert Volume	4	Apply
Ring Limit	No limit	

ⓘ 1 ring = 6 seconds.

Inbound Page Settings

Page Speaker Volume	4	Apply
<small>ⓘ When in Slave mode, note that this is the default volume control for all audio received via multicast.</small>		
Page Mode	<input checked="" type="radio"/> One-way <input type="radio"/> Two-way <input type="radio"/> Delayed	
<small>ⓘ "Delayed" mode stores the page audio temporarily, and then broadcasts it after the call is hung-up. This can help avoid feedback.</small>		
Page Timeout	5 minutes	
<small>ⓘ Maximum page timeout in Delayed mode is 5 minutes.</small>		
Page Tone	<Default>	
<small>ⓘ Use only Default, or custom uploaded file. The other pre-installed tone files all contain silence at the end in order to generate ring "cadence" of 6 seconds. This silence will block the voice path for several seconds at the start of a page.</small>		
G.722 Support	<input checked="" type="radio"/> Enabled <input type="radio"/> Disabled	
<small>ⓘ Applies to codec used during SIP negotiation only. Multicast codec is configured separately.</small>		

Audio Processing

Ambient Noise Compensation	<input type="radio"/> Enabled <input checked="" type="radio"/> Disabled	
<small>ⓘ Automatically adjust speaker level in response to ambient noise level detected at the device prior to start of each call.</small>		
Automatic Gain Control (AGC)	<input checked="" type="radio"/> Enabled <input type="radio"/> Disabled	
<small>ⓘ Automatically maximize level of voice received from calling phone in order to make page volume more consistent.</small>		

✔ Save

Ring/Alert Tone

Select WAV file to play when a ring event is detected on the SIP Ring extension. The WAV file may be played immediately to the speaker from the web interface for test purposes using the Play, Loop, and Stop buttons. During multicast, the device will broadcast an audio stream using the Master's selected ring tone.



Note: This is the "Default" tone that will be played if selected for Multicast, Additional Ring Extension settings.

Ring/Alert Volume

Set speaker volume for SIP ring event. This setting is an amplifier gain control and the output level will also depend on the levels recorded into the source WAV file played from memory. This setting is only used for local tones, and not when receiving multicast (see Page Speaker Volume below).

Ring Limit

Typically set to no limit, this feature can be used to set a limit on how long the speaker will ring before timing out. A new ring event is required before the speaker will play the WAV file again.

Page Speaker Volume

Speaker page volume control for SIP or multicast paging. This setting is an amplifier gain control and output level will depend on streaming level. This setting will apply to all multicast, regardless of content.

Page Mode

A call to the SIP page extension can be one-way, two-way using the integrated microphone, or delayed. In delay mode, the speaker will store the page into memory and then play after disconnect.

In delay mode, press “*” to cancel a page while the recording state is in process to prevent it from being sent after hanging up.

Page Timeout

A time limit may be set for an active page.

Page Tone

Select pre-announce tone for paging. Use only Default, or custom uploaded file. The other pre-installed tone files all contain silence at the end in order to generate ring "cadence" of 6 seconds. This silence will block the voice path for several seconds at the start of a page. The "Default" tone will play the page-notif.wav file.



Note: The "Default Page Tone", in Advanced Multicast, will play the tone set here.

G.722 Support

Enable or disable the G.722 codec.

Ambient Noise Compensation

To configure, set the volume to an appropriate level for a quiet environment and enable the Ambient Noise Compensation. The integrated microphone will measure the ambient noise during idle periods and automatically increment the speaker volume, if any increase in background noise is detected. Ambient noise level is averaged over 10 seconds. The noise compensation will not be functional when playing background music.

Automatic Gain Control (AGC)

Normalizes the audio level. Automatically maximize level of voice received from calling phone in order to make page volume more consistent.

Basic Settings Tab – Multicast

Multicast IP Addresses

Each 8180 SIP Audio Alerter (G2) has its own IP address, and shares a common multicast IP and port number (multicast zone) for multicast packets. The master speaker transmits to a configurable multicast zone, and the slave units listen to all the multicast zones assigned to them.

The network switches and router see the packet and deliver it to all the members of the group. The multicast IP and port number must be the same on all the master and slave units of one group. The user may define multiple zones by picking different multicast IP addresses and/or port numbers.

1. Multicast IP addresses range: 224.0.0.0/4 (from 224.0.0.0 to 239.255.255.255)
2. Port numbers range: 1 to 65535
3. By default, the 8180 SIP Audio Alerter (G2) is set to use the multicast IP address 224.0.2.60 and the port numbers 50000-50008

Make sure that the multicast IP address and port number do not conflict with other services and devices on the same network.

Multicast Page Zones

The 8180 SIP Audio Alerter (G2) supports nine “basic” multicast zones. These zones are defined by the multicast IP addresses.

Somewhat arbitrarily, these zones are defined below but may be used in other ways. The important consideration is that there is a priority hierarchy – streaming activity on a zone higher on the list, will be treated as a higher priority than a zone lower on the list – with music being the lowest priority.

1. Priority
2. All Call
3. Zone 1
4. Zone 2
5. Zone 3
6. Zone 4
7. Zone 5
8. Zone 6
9. Music

“Expanded” zones can also be enabled, in the **Basic Settings > Multicast tab**, allowing up to 50 zones in total. These have the same behaviors as the basic zones, but are hidden by default to simplify the interface.

Basic Settings Tab – Multicast (Master Settings)

Status
Basic Settings
Additional Features
Advanced Settings
System
Logout

SIP
Features
Multicast

Multicast Settings

Multicast Mode

Multicast Mode None Master/Sender Slave/Receiver
 ⓘ Multicast Zone Definitions can be found in "Advanced Settings > [Advanced Multicast](#)".

Multicast Type Regular (RTP) Polycom Group Page Polycom Push-to-Talk Regular RTP + Polycom Group Page Regular RTP + Polycom Push-to-Talk
 ⓘ Regular mode uses RTP audio packets compatible with all Algo SIP endpoints, and most multicast-enabled phones.
 ⓘ Both "RTP + Polycom" multicast types will enable local speaker playback for all groups and zones.

Number of Zones Basic Zones Only Basic and Expanded Zones

Polycom Group Paging/ Push-to-Talk

Polycom Zone
 ⓘ Enter the same Multicast IP Address & Port number as configured on the Polycom phones.

Polycom Group Selection Mode DTMF Selectable Group Single Group

Polycom Default Channel

Master/Sender Zone Settings

Zone Selection Mode DTMF Selectable Zone Single Zone
 ⓘ For additional capabilities allowing unique SIP extensions per zone, see "Additional Features > [More Page Extensions](#)".

Master Single Zone
 ⓘ If "DTMF Selectable Zone" is selected above, then this single zone setting will not apply to Paging (since the zone can now be dynamically selected per call using DTMF), but it will still apply to the Ring Extension and Relay triggered events.

DTMF Tone Settings

Zone Selection Tone

Note: See ([Advanced Settings > Advanced Multicast](#)) section for more information on populated IP values below:

Multicast Mode (Master/Sender Selected)

If master is enabled the 8180 SIP Audio Alerter will broadcast an IP stream when activated in addition to playing the audio over its own speaker. (Note that the 8180 cannot be both a multicast Master and Slave simultaneously).

Number of Zones

Select "Basic Zones Only" if configuring nine or fewer multicast zones (shown beside "Speaker Playback Zones") or select "Basic and Expanded Zones" to configure up to 50 zones. The expanded zones have the same behavior as the basic Slave zones, but are hidden by default to simplify the interface.

Status Basic Settings Additional Features Advanced Settings System Logout

SIP Features **Multicast**

Multicast Settings

Multicast Mode

Multicast Mode None Master/Sender Slave/Receiver
1 Multicast Zone Definitions can be found in "Advanced Settings > [Advanced Multicast](#)".

Multicast Type Regular (RTP) Polycom Group Page Polycom Push-to-Talk Regular RTP + Polycom Group Page Regular RTP + Polycom Push-to-Talk
1 Regular mode uses RTP audio packets compatible with all Algo SIP endpoints, and most multicast-enabled phones.
1 Both "RTP + Polycom" multicast types will enable local speaker playback for all groups and zones.

Number of Zones Basic Zones Only Basic and Expanded Zones

Master/Sender Zone Settings

Zone Selection Mode DTMF Selectable Zone Single Zone
1 For additional capabilities allowing unique SIP extensions per zone, see "Additional Features > [More Page Extensions](#)".

Master Single Zone
1 If "DTMF Selectable Zone" is selected above, then this single zone setting will not apply to Paging (since the zone can now be dynamically selected per call using DTMF), but it will still apply to the Ring Extension and Relay triggered events.

Speaker Playback Zones Priority Call All Call Music
 Zone 1 Zone 2 Zone 3
 Zone 4 Zone 5 Zone 6
1 Allows master device to play audio for selected zones only. This is useful if using DTMF Selectable Zone mode (or [More Page Extensions](#) per zone) and wishing to make the Master unit a member of only certain zones.

Expanded Speaker Playback Zones
 Zone *10 Zone *11 Zone *12 Zone *13 Zone *14
 Zone *15 Zone *16 Zone *17 Zone *18 Zone *19
 Zone *20 Zone *21 Zone *22 Zone *23 Zone *24
 Zone *25 Zone *26 Zone *27 Zone *28 Zone *29
 Zone *30 Zone *31 Zone *32 Zone *33 Zone *34
 Zone *35 Zone *36 Zone *37 Zone *38 Zone *39
 Zone *40 Zone *41 Zone *42 Zone *43 Zone *44
 Zone *45 Zone *46 Zone *47 Zone *48 Zone *49
 Zone *50

DTMF Tone Settings

Zone Selection Tone

Multicast Type

The 8180 SIP Audio Alerter (G2) may broadcast multicast paging, compatible with Polycom **“on premise group paging”** protocol and most multicast-enabled phones that use RTP audio packets.

Select “Regular” if solely multicasting to Algo SIP endpoints and/or multicast-enabled phones.

To multicast page announcements solely to Polycom phones, select “Polycom Group Page” or “Push-to-Talk”. Then, configure the 8180 with “Polycom Zone” (IP Address and Port) and “Polycom Default Channel”. *Always ensure that the multicast settings on all Slaves match those of the Master.*

Select “Regular RTP + Polycom Group Page/Push-to-Talk” to multicast page audio to both Polycom phones, Algo SIP endpoints, and multicast-enabled phones.

Polycom Group Selection Mode

“Single Zone” always broadcasts on one pre-configured Polycom Group. In “DTMF Selectable Zone” mode, the group is determined by the DTMF selection between 1 and 25.



Note: DTMF Codes for groups 10 and higher start with an “”.*

Zone Selection Mode

‘Single Zone’ always broadcasts on one IP address. ‘DTMF Selectable Zone’ mode, offers dynamic zone selection and requires only the master device to have a registered SIP Extension. The zone definitions can be found in the **Advanced Settings > Advanced Multicast** tab.

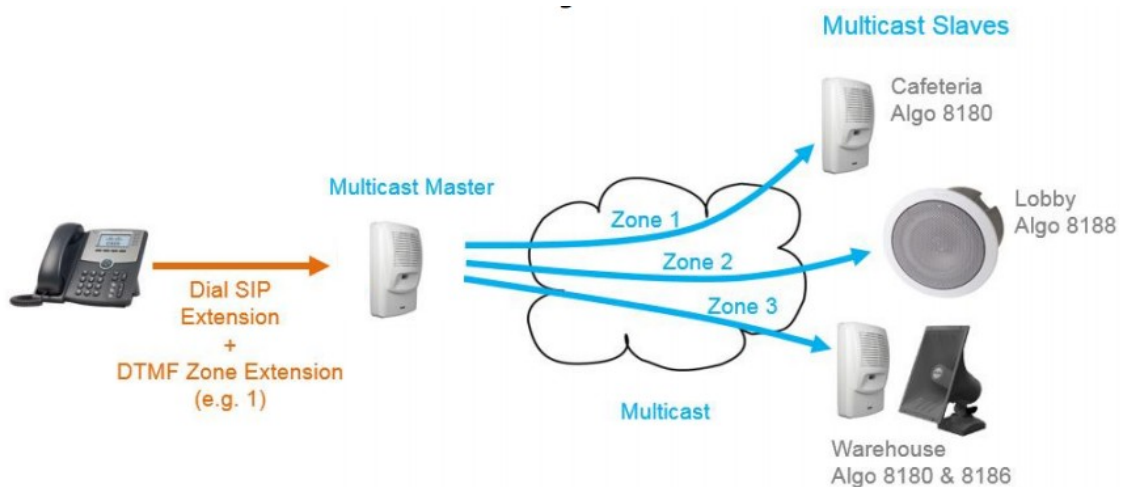

In ‘DTMF Selectable Mode’, to page, dial the SIP extension of the master device: #####, then dial the desired DTMF page zone (e.g. 1, 2, etc.) on the keypad when prompted.

1. Press DTMF Extension 9 for Priority Call
2. Press DTMF Extension 0 (or 8) for All Call
3. Press DTMF Extension 1 for Zone 1...
4. Press DTMF Extension *10 for Zone 10
5. Press DTMF Extension *11 for Zone 11...



Note: DTMF codes for zones 10 and higher start with an “”*

Alternatively, multiple SIP extensions can be registered on the Master device. Each extension is mapped to a unique zone, allowing zones to be called directly (for instance from speed-dial keys) without the use of DTMF. See **Additional Features > More Page Extensions** tab.

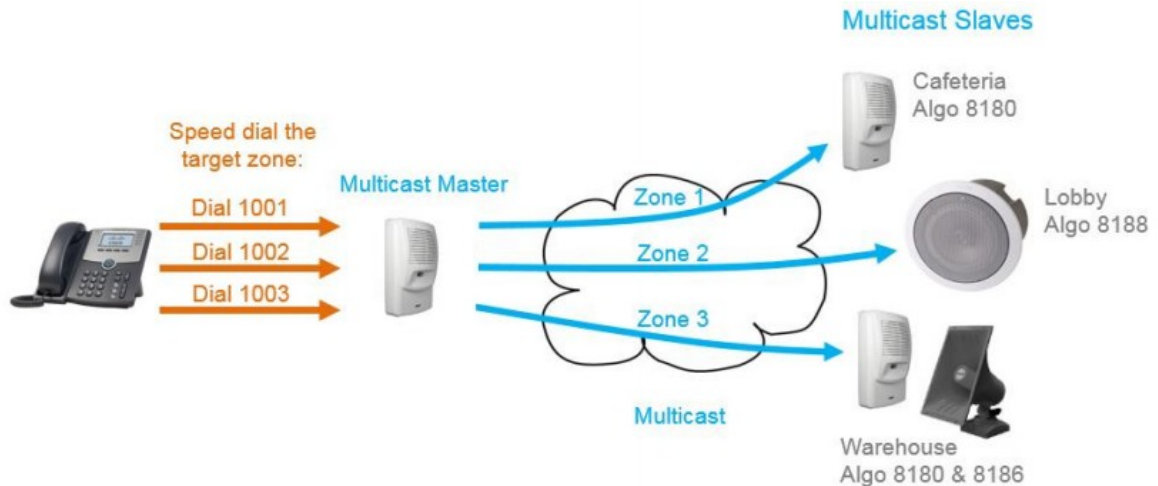

Zone Selection Tone

Only visible when 'Zone Selection Mode' is set to 'DTMF Selectable Zone'. The tone played over the phone to prompt the user to select a zone to multicast to.

Master Single Zone

The zone that multicast stream will be sent to. If 'DTMF Selectable Zone' is chosen above, this setting will not apply to Paging, since the zone now must be dynamically selected per call via DTMF. However, the specified 'Master Single Zone' setting is still used for any multicast events triggered by the Ring, analog input, or the relay input.

Speaker Playback Zones

Allows Master device to play audio for selected zones only. This is useful if using DTMF Selectable Zone mode (or More Page Extensions per zone) and wishing to make the Master unit a member of only certain zones.

Basic Settings Tab – Multicast (Slave Settings)

The screenshot shows the 'Multicast Settings' configuration page. At the top, there are navigation tabs: Status, Basic Settings (selected), Additional Features, Advanced Settings, System, and Logout. Below these, there are sub-tabs: SIP, Features, and Multicast (selected). The main content area is titled 'Multicast Settings' and contains several sections:

- Multicast Mode:** Includes radio buttons for 'None', 'Master/Sender', and 'Slave/Receiver' (which is selected). A note below states: 'Multicast Zone Definitions can be found in "Advanced Settings > Advanced Multicast".'
- Multicast Type:** Includes radio buttons for 'Regular (RTP)' (selected), 'Polycom Group Page', and 'Polycom Push-to-Talk'. A note below states: 'Regular mode uses RTP audio packets compatible with all Algo SIP endpoints, and most multicast-enabled phones.'
- Number of Zones:** Includes radio buttons for 'Basic Zones Only' and 'Basic and Expanded Zones' (which is selected).
- Slave/Receiver Zone Settings:**
 - Basic Slave Zones:** Includes checkboxes for 'Priority Call' (checked), 'All Call' (checked), and 'Music'. Below these are checkboxes for 'Zone 1' through 'Zone 6'.
 - Expanded Slave Zones:** Includes checkboxes for 'Zone *10' through 'Zone *50'. Below this list are 'Select All' and 'Clear All' buttons.

A 'Save' button with a green checkmark is located at the bottom right of the form.

Multicast Mode (Slave Selected)

If Slave is enabled the 8180 will activate when receiving a multicast message. Will mimic audio stream, but use local volume settings ('Page Speaker Volume' in Basic Settings > Features).

Number of Zones

Select 'basic' zones if configuring nine or fewer multicast zones or 'expanded' to configure up to 50 zones. The expanded zones have the same behavior as the basic Slave zones, but are hidden by default to simplify the interface.

Multicast Type - Regular

Select 'Regular (RTP)' if solely multicasting to Algo SIP endpoint(s) and/or multicast enabled phone(s) that use RTP audio packets.

Multicast Type – Polycom Group Paging/Push-to-Talk

The 8180 SIP Audio Alerter (G2) may receive multicast paging compatible with Polycom **“on premise group paging”** protocol.

To configure the 8180 as a slave to play Polycom page announcements, select “Group Page” or “Push-to-Talk”. Then enter the Polycom Zone (IP Address and Port) that matches the configuration of the Polycom phones and Channels. The “Default Channel” is

the target group in a Polycom paging environment.

The screenshot shows the 'Multicast Settings' page with the following configuration:

- Multicast Mode:** None, Master/Sender, Slave/Receiver. A note indicates: "Multicast Zone Definitions can be found in 'Advanced Settings > Advanced Multicast'".
- Multicast Type:** Regular (RTP), Polycom Group Page, Polycom Push-to-Talk. A note indicates: "Regular mode uses RTP audio packets compatible with all Algo SIP endpoints, and most multicast-enabled phones."
- Polycom Group Paging/ Push-to-Talk:**
 - Polycom Zone:** 224.0.1.116:5001. A note indicates: "Enter the same Multicast IP Address & Port number as configured on the Polycom phones."
 - Polycom Slave Channels:** A grid of checkboxes for groups 1 through 25. Groups 1, 24, and 25 are checked. Below the grid are "Select All" and "Clear All" buttons.

A "Save" button is located at the bottom right of the form.

The Polycom phone used as page audio source for the 8180 SIP Audio Alerter (G2)(s), must be configured to use either the G.711 or G.722 audio codec. The Polycom phone(s) must also be configured with the "Compatibility" setting ("ptt.compatibilityMode") disabled in order for this codec setting to be applied.

If using a Polycom phone as the Multicast master, a tone may be set for any of the 25 Polycom Groups configured on the Algo device. If an Algo device is used as a Multicast master, a tone does not have to be set as the Algo master will provide its own tone. Polycom Group Tones can be set in Advanced Settings > Advanced Multicast tab.

Slave Zones

Select one or more multicast zones for the 8180 SIP Audio Alerter (G2) to monitor. Note that multicast zone priority is based on the zone definition list order (top to bottom).

Web Interface Additional Features

Additional Features Tab – Input/Output

Status | Basic Settings | **Additional Features** | Advanced Settings | System | Logout

Input/Output | Emergency Alerts | More Page Extensions | More Ring Extensions

Input/Output

Terminal Block Functions

Speaker Mode Auto Internal External Disabled
ⓘ Note that Auto mode is not available when the Relay Terminal Function is set to Input.

Relay Terminal Function Output Input

Input

Relay Input Mode Disabled
 Relay Normally Open
 Relay Normally Open with Supervision (e.g. Algo 1203 Call Switch)
 Relay Normally Closed
 Relay Normally Closed with Supervision
 Mute Switch
 Mute Switch with Supervision
 Algo 1202 Call Button
 Algo 1204 Volume Control Switch
 Algo 1204 Volume Control Switch with Supervision

Audio Streaming

Microphone Always On Enabled Disabled
ⓘ This feature will stream the microphone audio via multicast for monitoring applications. When microphone streaming is active, the device will act as multicast Master regardless of the setting in Basic Settings > Multicast. Note that streaming is only available while the device is idle (it will be interrupted if a Page call is active).

Multicast Zone
ⓘ Multicast Zone Definitions can be found in "Advanced Settings > Advanced Multicast".

Action When Input Triggered

Action Play Tone Make SIP Voice Call Make SIP Call with Tone Stream Mic Audio
ⓘ "Play Tone" will play a recorded audio file to a local speaker and multicast if configured. "Stream Mic Audio" will stream microphone audio to multicast only, so it requires Multicast "Master" mode to be enabled in "Basic Settings > Multicast".

Extension to Dial
ⓘ SIP account required in Page Extension fields in order to make a call.

Allow 2nd Button Press Disabled End and Restart Call End Call

Tone/Pre-recorded Announcement

Interval Between Tones (seconds)

Maximum Tone Duration

Action When Tamper Detected

Action Play Tone Make SIP Voice Call Make SIP Call with Tone
ⓘ "Play Tone" will play a recorded audio file to a local speaker and multicast if configured. "Stream Mic Audio" will stream microphone audio to multicast only, so it requires Multicast "Master" mode to be enabled in "Basic Settings > Multicast". Note that this action will occur 5 seconds after a wiring fault is detected. If the fault is resolved within 5 seconds, this action will not occur.

Tone/Pre-recorded Announcement

Tone Duration Play Once Play While Held

Outbound SIP Call Settings

Outbound Ring Limit
ⓘ 1 ring = 6 seconds

Maximum Call Duration

Output

Output Light Enabled Disabled
ⓘ Disable the light on the speaker entirely (keep the light off even when the speaker is active).

Output Light Colour Blue Red

Heartbeat Light Enabled Disabled
ⓘ Flash the light every 30 seconds to indicate that the device is powered and running.

Save

Speaker Mode

Auto: Detect automatically if an external speaker is connected to the 8180.

External/Internal: Manually select which speaker to use.

Disabled: No audio

Relay Terminal Function

Can behave as an input or and output relay.

Relay Terminal Function – Output

Relay can trigger external light or other device when specified event occurs

Relay Terminal Function – Input

When triggered by an input relay, 8180 SIP Audio Alerter (G2) can perform actions such as playing a pre-recorded announcement over the speaker(s), sending the announcement as a private message to a phone, or initiating a two-way conversation between the speaker and a phone.

Relay Input Mode

The input relay to the 8180 SIP Audio Alerter (G2)(s) can be prompted by any normally open or normally closed switch. Algo offers the 1202 Call Button, the 1203 Call Switch, or the 1204 Volume Control Switch with supervision. Via supervision settings, notification actions can also be triggered if the input switch is disconnected.

1203 Call Switch



The 1203 Call Switch is a simple contact closure switch with an illuminated button and supervision capabilities. When used in conjunction with the 8180, the 1203 can prompt a single action with one-touch, or a continuous action if the button is held.

Mute Switch

Apply an external switch (short-circuit) across the Relay Input terminals 5 & 6 in order to mute the speaker. This allows a temporary "disable" switch to control the device if desired, for example in a boardroom to block paging during important meetings.

Leave the Relay Input terminals open (no-connect) for regular full-volume operation when in this mode.

1202 Call Button



The 1202 Call Button is a one-touch button for event notification and response. It can be used with the 8180 for improved customer service, emergency notification, and non-emergency alerting. The Call Button's one-touch button can trigger a single or continuous action, which can be halted via the small cancel/reset button located below the main call button.

While the 8180 can be configured to play the WAV file only once, it can also be enabled to play it continuously with just one touch on the 1202 Call Button. The action can then be stopped via the smaller oval cancel button located below the main call button on the 1202 Call Button.

1204 Volume Button



The 1204 Volume Control Switch is a simple 2 terminal potentiometer that will allow attenuation below the max volume level (configured under 'Basic Settings > Features')

Algo's 1204 can be used for variable volume control. The maximum volume should still be set in the Basic Settings > Features tab as usual, and then the Volume Control Switch will allow attenuation below this level. Enabling Priority Multicast Override allows priority multicast to override the volume set by the Volume Control Switch. Enabling 'Mute On Lowest Setting' allows audio to be completely muted when volume control switch is turned all the way down.

Action – Play Tone

When the 8180 input is triggered on terminals 5 & 6 ('Relay Terminal Function' must also be configured to 'Input'), a tone or a pre-recorded WAV file will play over the local speaker, or multicast if enabled. This function can be used to call support/assistance in service or retail environments, notify about an emergency at a specific location in medical or educational facilities, or sound an alarm during an intrusion.

- Action When Input Triggered:
 - o Tone/Pre-recorded Announcement
 - o Tone Duration

Action – Make SIP Voice Call

When the 8180 input is triggered on terminals 5 & 6, a voice path will open for an intercom-like call via the 8180 to a pre-configured phone extension. This option can be used when a call needs to be made from a public place where a phone would not be practical to use.

- Action When Input Triggered:
 - o Extension to Dial
 - o Call Mode
 - o Allow 2nd Button Press
- Outbound SIP Call Settings:

- o Outbound Ring Limit
- o Ringback Tone
- o Maximum Call Duration

Action – Make SIP Call with Tone

When the 8180 input is triggered on terminals 5 & 6, a private call can be generated to a pre-configured phone extension with a pre-recorded message. For instance, a call to a supervisor's phone notifying about an emergency or intrusion at some location.

- Action When Input Triggered:
 - Extension to Dial
 - Allow 2nd Button Press
 - Tone/Pre-recorded Announcement
 - Interval Between Tone (seconds)
 - Maximum Tone Duration
- Outbound SIP Call Settings:
 - Outbound Ring Limit
 - Ringback Tone

Action – Stream Mic Audio

Will stream audio heard over the microphone onto local speaker, as well as over multicast if configured. "Microphone Always On" will be disabled because this feature should only trigger from an action and not always.

Action When Tamper Detected (Supervision)

In addition to the main events, the device can be configured with supervision to also execute one of the above three actions in case the device goes offline due to wiring failure or after being tampered with. For example, a tone could sound over the speaker(s), or a private pre-recorded message could be sent to a specified phone extension. The supervision configuration options will appear once a relay option with supervision is selected. See the Electrical Specification section for details on supervision detection circuit.

Microphone Always On

The microphone audio will stream via multicast for monitoring applications. When microphone streaming is active, the device will act as multicast Master regardless of the setting in Basic Settings > Multicast. Note that streaming is only available while the device is idle (it will be interrupted if a Page call is active).

Extension to Dial

SIP account required in Page Extension fields in order to make a call. Can be configured if 'Make SIP Voice Call' or 'Make SIP Call with Tone' actions are enabled under 'Call Button Settings'.

Interval Between Tones

Specify the time delay (seconds) between tones. Can be configured if 'Play Tone' or 'Make SIP Call with Tone' actions are enabled under 'Call Button Settings'.

Maximum Tone Duration

Select the maximum tone duration. The tone will be terminated once the maximum time is reached. Can be configured if 'Play Tone' or 'Make SIP Call with Tone' actions are enabled.

Call Mode

This setting is available when the 'Make SIP Call with Tone' action is enabled and 'Relay Input Mode' is set to one of the Relay options. If the 'Regular Two-Way Call' setting is chosen, a relay closure will prompt an intercom-like call via the speaker and its microphone to a pre-configured extension. When the "Silent Microphone Monitoring" is enabled, the relay will prompt only the audio from the 8180's microphone to be heard at the pre-configured extension, while the speaker remains silent. This setting is ideal in settings where silent emergency calls to a pre-configured extension may be needed with a single press of a button.

Allow 2nd Button Press

If enabled, 2nd button press will either simply End Call or End and Restart Call. Therefore, if an input is triggered for the second time on terminals 5 & 6 (since the first input trigger enables one of the four actions listed above) the SIP call will either simply be terminated or terminated and immediately called again.

Outbound Ring Limit

Typically set to ensure that a call will not reach voicemail. This feature, under 'Outbound SIP Call Settings', can be used to set a limit on how long the speaker will ring before timing out.

Ring back Tone

If enabled, under 'Outbound SIP Call Settings', a ringback tone will play over the speaker during an outbound SIP call, while waiting for the far-end party to answer.

Maximum Call Duration

Select the maximum call length. The call will be terminated once the maximum time is reached. In the event that a call inadvertently reaches voicemail or gets accidentally left on hold, this setting ensures that the 8180 returns on-hook.

Output Light

Enable/Disable the blue light on the speaker entirely (keep the light off even when the speaker is active).

Output Light Colour

Configure the LED colour as either blue or red.

Heartbeat Light

If enabled, the small blue indicator will flash every 30 seconds as visual confirmation that the 8180 is powered and running.

Output Relay

Only visible when 'Relay Terminal Function' set to 'Output'.

Additional Features Tab – Emergency Alerts

Status
Basic Settings
Additional Features
Advanced Settings
System
Logout

Input/Output
Emergency Alerts
More Page Extensions
More Ring Extensions

Emergency Alerts

ⓘ This section allows pre-recorded announcements to be triggered & latched by calling an extension and hanging up. The announcement will continue to play until a different "Cancel" extension is called to clear the announcement (or a pre-defined timeout is reached). This can be useful for emergency notifications (e.g. "Evacuation Alert"), allowing staff to quickly dial a pre-configured number and then exit the building. Audio files can be easily uploaded to create custom announcements.

ⓘ Up to 10 extensions can be registered allowing up to 10 different announcements. A single "Cancel" extension also needs to be registered; calling this number will cancel the currently active announcement.

ⓘ Note: Some SIP phone systems may not support this feature if they limit the number of extensions that can be registered on a single device.

Settings

Announcement Duration Play Once Play Until Cancelled

Maximum Announcement Time 10 minutes

Answer Inbound Call Enabled Disabled

ⓘ This option selects how the Announcement calls are handled. In both cases, the Emergency Announcement is started when the appropriate extension is called and continues until the Cancel Extension is called.
 ⓘ Select "Enabled" to answer the inbound call and provide the option to play a confirmation tone before starting the alert, then automatically release the call.
 ⓘ Select "Disabled" to detect just the inbound Ring signal, but not actually answer the call

Call-to-Cancel

Extension

Authentication ID

Authentication Password

Confirmation Tone <None>

Announcements

Announcement 1	<input type="radio"/> Enabled <input type="radio"/> Disabled
Announcement 2	<input type="radio"/> Enabled <input type="radio"/> Disabled
Announcement 3	<input type="radio"/> Enabled <input type="radio"/> Disabled
Announcement 4	<input type="radio"/> Enabled <input type="radio"/> Disabled
Announcement 5	<input type="radio"/> Enabled <input type="radio"/> Disabled
Announcement 6	<input type="radio"/> Enabled <input type="radio"/> Disabled
Announcement 7	<input type="radio"/> Enabled <input type="radio"/> Disabled
Announcement 8	<input type="radio"/> Enabled <input type="radio"/> Disabled
Announcement 9	<input type="radio"/> Enabled <input type="radio"/> Disabled
Announcement 10	<input type="radio"/> Enabled <input type="radio"/> Disabled

✔ Save

Emergency Alerts allow for an announcement to be triggered & latched by calling a pre-configured Emergency extension and hanging up. The announcement will continue to play until a different "Cancel" extension is called to clear the announcement (or a defined timeout is reached). The Emergency Alerts are useful for emergency notifications (e.g. evacuation, lock down, medical emergency, etc.), allowing staff to quickly dial a pre-configured number under such circumstances.

If the "Answer Inbound Call" option is "Enabled" the call is auto-answered and a confirmation tone is played before starting the alert. If "Disabled", the alert is triggered just by the inbound ring, without answering the call. (In both instances, the announcement will

play until the time limit is reached or the “Cancel Extension” is called). The auto-answering option can be useful when the caller cannot hear announcement from their location. However, in instances where the call might go to a group/multiple extensions (including this device), the auto-answer may intercept that call and prevent it from ringing on other devices.

Up to 10 extensions can be registered allowing up to 10 different announcements. Audio files can also be easily uploaded to create custom announcements.



Note: Some SIP phone systems may not support this feature if they limit the number of extensions that can be registered on a single device.

Additional Features Tab – More Page Extensions

The screenshot shows the 'More Page Extensions' configuration page. At the top, there are navigation tabs: Status, Basic Settings, **Additional Features**, Advanced Settings, System, and Logout. Below these are sub-tabs: Input/Output, Emergency Alerts, **More Page Extensions**, and More Ring Extensions. The main heading is 'More Page Extensions'. Below the heading is a descriptive paragraph: 'This section allows dedicated extensions to be registered for each paging zone. This provides an alternative to the "DTMF Selectable Zone" option, thus allowing any zone to be called directly without the need to enter DTMF. Depending on the features available in your SIP phone system, this can provide benefits in allowing speed-dial keys to be programmed on user phones for paging a particular zone more easily, or dialing restrictions could potentially be used to allow only selected phones to access certain zones. This feature requires several SIP extensions to be registered with the SIP phone system of course.' There are three informational icons: 1. 'The 8180G2 will auto-answer any inbound calls received on these numbers and provide a voice paging path and multicast if configured. Note that only a single call can be active at a time.' 2. 'Note: Some SIP phone systems may not support this feature if they limit the number of extensions that can be registered on a single device.' 3. 'Multicast Zone Definitions can be found in "Advanced Settings > Advanced Multicast".' Below this is the 'Basic Extensions' section with a list of settings, each with an 'Enabled' radio button selected: Priority Call Page Extension, Extension (input field), Authentication ID (input field), Authentication Password (input field with a lock icon), All Call Page Extension, Zone 1 Page Extension, Zone 2 Page Extension, Zone 3 Page Extension, Zone 4 Page Extension, Zone 5 Page Extension, Zone 6 Page Extension, and Music Page Extension. Below that is the 'Expanded Extensions' section with two settings, each with an 'Enabled' radio button selected: Zone 10 Page Extension and Zone 11 Page Extension.

Additional SIP extensions can be registered for each multicast zone that will be used. This allows the advantage of dialing directly to a zone without needing to enter DTMF Codes (e.g. speed-dial keys can be used), but this may require additional SIP licenses depending on the SIP provider.

To configure additional page extensions (up to 50) click “Enable” beside the target extension and enter the Extension, Authentication ID, and Authentication password.

The 8180 will auto-answer any inbound calls received on these numbers and provide a voice paging path and multicast if configured. Note that only a single call can be active at a time.



Note: Some SIP phone systems may not support this feature if they limit the number of extensions that can be registered on a single device.

Multicast Zone Definitions can be found in Advanced Settings > Advanced Multicast.

Additional Features Tab – More Ring Extensions

More Ring Extensions

This section allows additional extensions to be registered for the purpose of providing loud ringing alerts for more than one line. Unique ring tones can be selected for each line to allow them to be easily distinguished - for example a "Sales" line could have a different ring tone from a personal line. Appropriate call routing must be configured on your SIP phone system of course in order to trigger it to send calls to these different numbers.

The 8180G2 will detect inbound ring events on these numbers and play the alerting tone until the inbound call stops ringing. It will not answer the calls in this mode.

Note: Some SIP phone systems may not support this feature if they limit the number of extensions that can be registered on a single device.

Ring Extension 2	<input checked="" type="radio"/> Enabled <input type="radio"/> Disabled
Extension	<input type="text"/>
Authentication ID	<input type="text"/>
Authentication Password	<input type="password"/>
Ring Tone	<Use Default Ring Tone>
Multicast Zone	<Use Default Multicast Zone>
Ring Extension 3	<input type="radio"/> Enabled <input checked="" type="radio"/> Disabled
Ring Extension 4	<input type="radio"/> Enabled <input checked="" type="radio"/> Disabled
Ring Extension 5	<input type="radio"/> Enabled <input checked="" type="radio"/> Disabled
Ring Extension 6	<input type="radio"/> Enabled <input checked="" type="radio"/> Disabled
Ring Extension 7	<input type="radio"/> Enabled <input checked="" type="radio"/> Disabled
Ring Extension 8	<input type="radio"/> Enabled <input checked="" type="radio"/> Disabled
Ring Extension 9	<input type="radio"/> Enabled <input checked="" type="radio"/> Disabled
Ring Extension 10	<input type="radio"/> Enabled <input checked="" type="radio"/> Disabled

Rule-based Ring Tone

#1 Custom Tone	<input type="radio"/> Enabled <input checked="" type="radio"/> Disabled
#2 Custom Tone	<input type="radio"/> Enabled <input checked="" type="radio"/> Disabled
#3 Custom Tone	<input type="radio"/> Enabled <input checked="" type="radio"/> Disabled
#4 Custom Tone	<input type="radio"/> Enabled <input checked="" type="radio"/> Disabled

Save

Up to 10 SIP Ring extensions can be registered. To configure additional ring extensions, click "Enable" beside the target extension and enter the Extension, Authentication ID, and

Authentication password. A unique Ring Tone can be assigned to each extension if desired.



Note: It is recommended that Provisioning Mode be set to Disabled if this feature is not in use. This will prevent unauthorized re-configuration of the device if DHCP is used.

Web Interface Advanced Settings

Advanced Settings Tab – Network

The screenshot displays the 'Advanced Settings' tab for the 'Network' section. It includes sub-tabs for Admin, Time, Provisioning, Tones, File Manager, Advanced Audio, Advanced SIP, and Advanced Multicast. The main content area is titled 'Network Settings' and is divided into three sections:

- Network Interface:** Features radio buttons for 'Static IP' (selected) and 'DHCP'. Below are input fields for IP Address, Netmask, Gateway, DNS Server 1, and DNS Server 2.
- 802.1Q Virtual LAN:** Features radio buttons for 'None', 'Manual', and 'Auto' (selected).
- Differentiated Services:** Contains three rows for SIP, RTP, and RTCP (6-bit DSCP value). Each row has an input field set to '0' and a tooltip indicating 'Valid values range from 0 to 63'.

A 'Save' button with a green checkmark is located at the bottom right of the form.

Protocol

DHCP is an IP standard designed to make administration of IP addresses simpler. When selected, DHCP will automatically configure IP addresses for each 8180 on the network. Alternatively, the 8180 can be set to a static IP address.

VLAN Mode

Enables or Disables VLAN Tagging. VLAN Tagging is the networking standard that supports Virtual LANs (VLANs) on an Ethernet network. The standard defines a system of VLAN tagging for Ethernet frames and the accompanying procedures to be used by bridges and switches in handling such frames. The standard also provides provisions for a quality of service prioritization scheme commonly known as IEEE 802.1p and defines the Generic Attribute Registration Protocol.

VLAN ID

Specifies the VLAN to which the Ethernet frame belongs. A 12-bit field specifying the VLAN to which the Ethernet frame belongs. The hexadecimal values of 0x000 and 0xFF are reserved. All other values may be used as VLAN identifiers, allowing up to 4094 VLANs. The reserved value 0x000 indicates that the frame does not belong to any VLAN; in this case, the 802.1Q tag specifies only a priority and is referred to as a priority tag. On bridges, VLAN 1 (the default VLAN ID) is often reserved for a management VLAN; this is vendor specific.

VLAN Priority

Sets the frame priority level. Otherwise known as Priority Code Point (PCP), VLAN Priority is a 3-bit field which refers to the IEEE 802.1p priority. It indicates the frame priority level. Values are from 0 (lowest) to 7 (highest).

802.1x Authentication

Credentials to access LAN or WLAN that have 802.1X network access control (NAC) enabled. This information will be available from the IT Administrator.

Differentiated Services (6-bit DSCP value)

Provides quality of service if the DSCP protocol is supported on your network. Can be specified independently for SIP control packets versus RTP audio packets.

DNS Caching Mode

In "SIP" mode, only the results of DNS queries for SIP requests will be cached. In "All" mode, the results of all DNS queries will be cached.

Advanced Settings Tab – Admin

The screenshot displays the 'Advanced Settings' tab for the 'Admin' user. The interface is organized into several sections:

- Admin Password:** Fields for 'Password' and 'Confirmation' with eye icons for visibility toggling.
- General:**
 - Device Name (Hostname): sipalerter
 - Introduction Section on Status Page: On Off
 - Show Status Section on Status Page when Logged Out: On Off
 - Web Interface Session Timeout: 1 hour (dropdown menu). Note: Automatically log out web interface after period of inactivity.
 - Play Tone at Startup: Enabled Disabled. Note: A tone can be played at startup to confirm that the device has booted.
- Log Settings:**
 - Log Level: Error (Lowest) Notice ("Event") Info ("SIP") Debug (Highest)
 - Log Method: Local Network Both
 - Log Server: (empty text field)
- Management:**
 - Web Interface Protocol: Both HTTP and HTTPS HTTPS Only
 - Force Strong Password: Enabled Disabled
 - Allow Secure SIP Passwords: Enabled Disabled. Note: After enabling this option, it is recommended to re-enter SIP passwords and their corresponding realm to store the passwords securely.
 - SNMP Support: Enabled Disabled. Note: Download MIB file [here](#).
- System Integrity:**
 - System Integrity Checking: Enabled Disabled. Note: This feature verifies installed system packages to ensure they have not been tampered with. Enabling this feature may cause reboots and upgrades to take 30 seconds longer. Verification results can be found on the Status page.
 - Perform Check:
- Syn-Apps:**
 - SA-Announce Support: Enabled Disabled
 - SA-Announce Server: (empty text field). Note: Leave this field blank to use the server provided by DHCP Option 72.
 - Local Management Port: 6789
- InformaCast:**
 - InformaCast Support: Enabled Disabled. Note: This feature requires a valid license to be activated. Please contact sales@algosolutions.com for assistance.

A green 'Save' button is located at the bottom right of the settings page.

Password

Password to log into the 8180 SIP Audio Alerter (G2) web interface. You should change the default password **algo** in order to secure the device on the network. If you have forgotten your password, you will need to perform a reset using the Reset Button in order to restore the password (as well as all other settings) back to the original factory default conditions.

For additional password security see "Force Strong Password" below.

Confirmation

Re-enter network admin password.

Device Name (Hostname)

Name to identify the device in the Algo Network Device Locator Tool.

Introduction Section on Status Page

Allows the introduction text to be hidden from the login screen.

Show Status Section on Status Page when Logged Out

Use this option if you wish to block access to the status page when logged out. The settings and configurations, on the status page, will be hidden entirely unless you're logged in – this feature is useful when you want only trusted users to view possible sensitive device information.

Web Interface Session Timeout

Set the maximum period of inactivity after which the web interface will log out automatically.

Play Tone at Startup

A tone can be played at startup to confirm that the device has booted.

Log Level

Use on the advice of Algo technical support only.

Log Method

Allows the 8180 SIP Audio Alerter (G2) to write to external Syslog server if the option for external (or both) is selected.

Log Server

If external (or both) is selected this is the address of the Syslog server on the network.

Web Interface Protocol

HTTPS is always enabled on the device. Use this setting to disable HTTP. When HTTP is disabled, requests will be automatically redirected to HTTPS. Also note that since the device can have any address on the local network, no security certificate exists, and thus most browsers will provide a warning when using HTTPS.

Force Strong Password

When enabled, ensures that a secure password is provided for the device's web interface for additional protection. The password requirements are:

- Must contain at least 10 characters
- Must contain at least 1 uppercase character
- Must contain at least 1 digit (0 – 9)

- Must contain at least 1 special character

Allow Secure SIP Password

Allows SIP passwords to be stored in the configuration file in an encrypted format, to prevent viewing and recovery. Once enabled, the SIP “Realm” field should be entered and all the configured Authentication Password(s) must be re-entered in the Basic Settings > SIP tab, and any other locations where SIP extension have been configured, to save the encrypted password(s).

If the Realm is changed at a later time, all the passwords will also need to be re-entered again to save the passwords with the new encryption.

To obtain your SIP Realm information, contact your SIP Server administrator (or check the SIP log file for a registration attempt). The Realms may be the same or different for all the extensions used.

SNMP Support

Additional SNMP support is anticipated for future, but the 8180 SIP Audio Alerter (G2) will respond to a simple status query for automated supervision. Contact Algo technical support for more information.

System Integrity Checking

This feature verifies installed system packages to ensure they have not been tampered with by running ‘Perform Check’. Enabling this feature may cause reboots and upgrades to take 30 seconds longer. Verification results can be found on the Status page.

SA-Announce Support

Syn-Apps’ SA-Announce paging application converts unicast streams to multicast and delivers them to the target endpoints. The feature can only be used on the 8180 when Multicast Master Mode is disabled (set to ‘None’) in the Basic Settings > Multicast tab.

SA-Announce Server

Enter the SA-Announce Server to use the Syn-Apps paging feature. To use the server provided by the DHCP Option 72, leave the field blank.

Local Management Port

Enter the local management port for the SA-Announce Server.

InformaCast Support

This feature requires a valid InformaCast license to be activated. Please contact sales@algosolutions.com for assistance.

Advanced Settings Tab – Time

The screenshot shows the 'Time Settings' configuration page. At the top, there are tabs for 'Status', 'Basic Settings', 'Additional Features', 'Advanced Settings' (selected), 'System', and 'Logout'. Below these are sub-tabs: 'Network', 'Admin', 'Time' (selected), 'Provisioning', 'Tones', 'File Manager', 'Advanced Audio', 'Advanced SIP', and 'Advanced Multicast'. The main content area is titled 'Time Settings' and contains a 'General' section with the following fields:

- Timezone:** A dropdown menu set to 'UTC'.
- NTP Time Server 1:** Text input field containing '0.debian.pool.ntp.org'.
- NTP Time Server 2:** Text input field containing '1.debian.pool.ntp.org'.
- NTP Time Server 3:** Text input field containing '2.debian.pool.ntp.org'.
- NTP Time Server 4:** Text input field containing '3.debian.pool.ntp.org'.
- NTP Time Server Source:** Radio buttons for 'Use DHCP Option 42' (selected) and 'Ignore DHCP Option 42'. A note below states: 'By default, if an NTP Server address is provided via DHCP Option 42, this will be used instead of the options above.'
- Device Date/Time:** A text field showing 'Mon Oct 22 18:12:22 2018' and a 'Sync with browser' button. A note below states: 'Manual time and date are intended for testing purpose only. Time will be lost upon power down.'

A green 'Save' button is located at the bottom right of the form.

Network time is used for logging events into memory for troubleshooting.

Time Zone

Select time zone.

NTP Time Servers 1/2/3/4

The speaker will attempt to use Timer Server 1 and work down the list if one or more of the time servers become unresponsive.

NTP Time Server Source

When “Use DHCP Option 42” is chosen, if an NTP Server address is provided via the DHCP Option 42, that NTP Server will be used instead of the 4 mentioned above. Alternatively, “Ignore DHCP Option 42” can be chosen to only use servers mentioned above.

Device Date/Time

This field shows the current time and date as set on the device. If testing the device on a lab network that may not have access to an external NTP server, the “Sync with browser” button can be used to temporarily set the time on the device.



Note: This time value will be lost at power down, or overwritten if NTP is currently active. Time and date are used only for logging purposes and are not typically required.

Advanced Settings Tab – Provisioning

 *Note: It is recommended that Provisioning Mode be set to Disabled if this feature is not in use. This will prevent unauthorized re-configuration of the device if DHCP is used.*

Provisioning allows installers to pre-configure 8180 SIP Audio Alerter (G2) units prior to installation on a network. It is typically used for large deployments to save time and ensure consistent setups.

The device can be provisioned via the Auto mode (where all three DHCP options (Option 66/160/150) will be automatically checked for an active provisioning server), just one of the three specified DHCP options, or a Static Server. In addition, there are four different ways to download provisioning files from a “Provisioning Server”: TFTP (Trivial File Transfer Protocol), FTP, HTTP, or HTTPS.

For example, 8180 configuration files can be automatically downloaded from a TFTP server using DHCP Option 66. This option code (when set) supplies a TFTP boot server address to the DHCP client to boot from.

 *Important: DHCP must be enabled if using DHCP Option 66/160/150, in order for Provisioning to work.*

One of two files can be uploaded on the Provisioning Server (for access via TFTP, FTP, HTTP, or HTTPS):

Generic (for all Algo 8180G2 Speakers) **algot8180g2.conf**

Specific (for a specific MAC address) **algot[MAC].conf**

Both protocol and path is supported for Option 66, allowing for <http://myserver.com/config-path> to be used.

MD5 Checksum

In addition to the **.conf** file, an **.md5** checksum file must also be uploaded to the Provisioning server. This checksum file is used to verify that the **.conf** file is transferred correctly without error.

A tool such as can be found at the website address below may be used to generate this file: <http://www.fourmilab.ch/md5>

The application doesn't need an installation. To use the tool, simply unzip and run the application (md5) from a command prompt. The proper **.md5** file will be generated in the same directory.

If using the above tool, be sure to use the "-l" parameter to generate lower case letters.

Generating a generic configuration file

1. Connect 8180 to the network
2. Access the 8180 Web Interface Control Panel
3. Configure the 8180 with desired options
4. Click on the System tab and then Maintenance.
5. Click "Download" to download the current configuration file
6. Save the file settings.txt
7. Rename file settings.txt to **algot8180g2.conf**
8. File **algot8180g2.conf** can now be uploaded onto the Provisioning server

If using a generic configuration file, extensions and credentials have to be entered manually once the 8180 SIP Audio Alerter (G2) has automatically downloaded the configuration file.

Generating a specific configuration file

1. Follow steps 1 to 6 as listed in the section "Generating a generic configuration file".
2. Rename file settings.txt to **algot[MAC address].conf** (e.g. **algot0022EE020009.conf**)
3. File **algot[MAC address].conf** can now be uploaded on the Provisioning server.

The specific configuration file will only be downloaded by the 8180 with the MAC address specified in the configuration file name. Since all the necessary settings can be included in this file, the 8180 will be ready to work immediately after the configuration file is

downloaded. The MAC address of each 8180 speaker can be found on the back label of the unit.

For more Algo SIP endpoint provisioning information, see:
www.algosolutions.com/provision

Advanced Settings Tab – File Manager

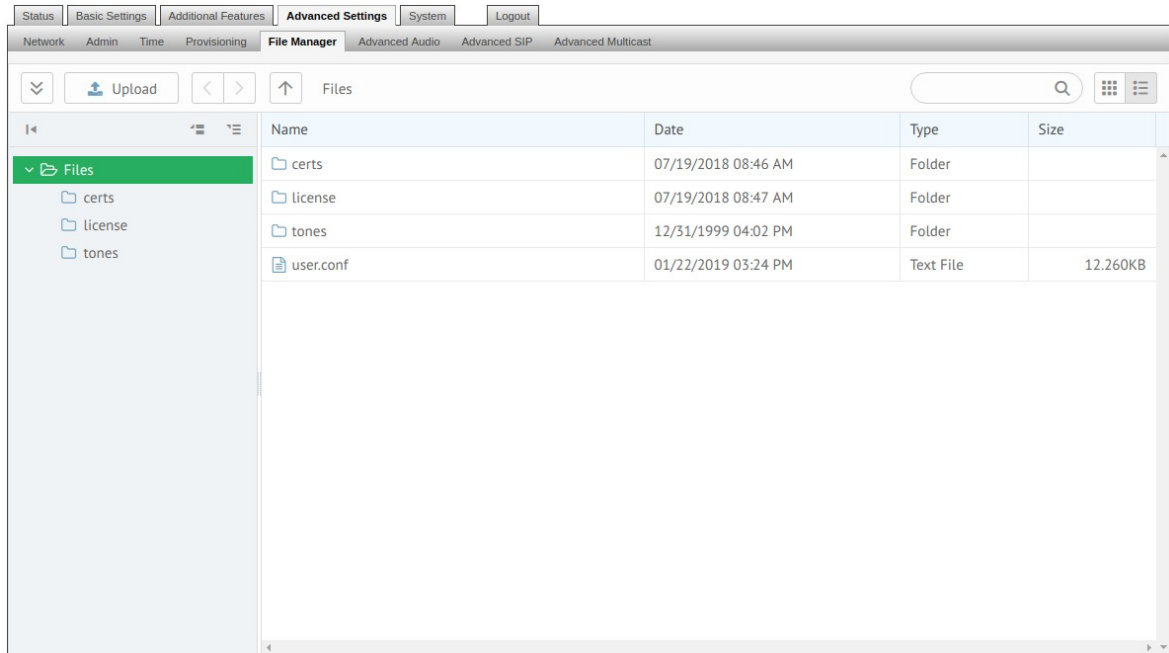

Uploading Custom Audio Files

Custom audio files (WAV format) may be uploaded into memory (1 GB) to play for notification applications. Place your audio files into the **tones** directory.

An existing file may also be modified by downloading the original by right clicking the tone and selecting 'Download', making the desired changes, and then uploading the new version with a different name. Audio files must be in the following format:

- WAV format
- 8kHz or 16kHz sampling rate
- 16-bit PCM, or u-law
- Mono
- Smaller than 200MB

File names must be limited to 32 characters, with no spaces.

Tone Files Included in Memory

The 8180 SIP Audio Alerter (G2) includes several pre-loaded WAV files that can be selected to play for various events. The web interface allows selection of the WAV file and also the ability to play the WAV file immediately over the speaker for testing. Files may also be deleted or renamed.

Advanced Settings Tab – Advanced Audio

The screenshot shows the 'Advanced Audio Functions' configuration page. It is divided into two main sections: 'Functions' and 'Audio Filters'.
Functions Section:
 - **Dynamic Range Compression (DRC):** Radio buttons for 'Enabled' and 'Disabled'. A help icon indicates: 'Compress the dynamic range of page audio to increase loudness.'
 - **Jitter Buffer Range (milliseconds, 10 ~ 500):** A text input field containing '100'. A help icon indicates: 'Adds more buffering if necessary to correct for inconsistent delays on the network. Use of the lowest value generally is recommended.'
 - **Always Send RTP Media:** Radio buttons for 'Enabled' and 'Disabled'.
Audio Filters Section:
 - **Speaker Filter:** A dropdown menu set to 'None'. A help icon indicates: 'Bandwidth also limited by audio codecs.'
 - **Speaker Noise Filter:** Radio buttons for 'Enabled' and 'Disabled'. A help icon indicates: 'Aggressive 8th order Elliptical Filter (fc = 145Hz)'.
 - **Microphone Filter:** A dropdown menu set to 'None'.
 - **Microphone Noise Filter:** Radio buttons for 'Enabled' and 'Disabled'. A help icon indicates: 'Aggressive 8th order Elliptical Filter (fc = 145Hz)'.
 A 'Save' button with a green checkmark is located at the bottom right of the configuration area.

Dynamic Range Compression (DRC)

If enabled, compresses the dynamic range of page audio to increase loudness.

Dynamic Range Compression Gain

'Dynamic Range Compression' must be enabled to display this setting. Higher compression gain increases distortion.

Jitter Buffer Range

The jitter buffer removes the jitter in arriving network packets by temporarily storing them. This process corrects the inconsistent delays on the network. It is recommended to use the lowest value.

Always Send RTP Media

If enabled, audio packets will be sent at all times, even during one-way paging mode. This option is needed in cases when the server expects to see audio packets at all times.

Speaker Filter

Applies a high-pass filter to the speaker output. Used to reduce audio artifacts like humming or buzzing by filtering out unwanted frequencies.

Speaker Noise Filter

Enables heavy filtering below 145Hz to reduce mains induced noise (fans).

Microphone Filter

Applies a high-pass filter to the microphone input. Used to reduce audio artifacts like humming or buzzing by filtering out unwanted frequencies.

Microphone Noise Filter

Enables heavy filtering below 145Hz to reduce mains induced noise (fans).

Advanced Settings Tab – Advanced SIP

The screenshot shows the 'Advanced SIP Settings' page in a web browser. The navigation tabs at the top include Status, Basic Settings, Additional Features, **Advanced Settings**, System, and Logout. Under 'Advanced Settings', there are sub-tabs for Network, Admin, Time, Provisioning, File Manager, Advanced Audio, **Advanced SIP**, and Advanced Multicast. The main content area is titled 'Advanced SIP Settings' and is divided into several sections:

- General:**
 - SIP Transportation:** A dropdown menu set to 'AUTO'. Below it are three informational icons: 1) 'Select Auto to check DNS NAPTR record, then try UDP/TCP.' 2) 'In TLS mode, if the SIP Server requires endpoints to be authenticated, a PEM file containing both a device certificate and a private key needs to be installed on the Algo device. Use the "Advanced Settings > File Manager" tab to upload a certificate file renamed to 'sipclient.pem' in the 'certs' folder.' 3) 'To force the Algo device to authenticate the SIP server, a certificate obtained from the SIP server needs to be installed. Use the "Advanced Settings > File Manager" tab to upload a certificate file renamed to 'siptrusted.pem' in the 'certs' folder.'
 - SDP SRTP Offer:** A dropdown menu set to 'Disabled'.
 - SIP Outbound Support (RFC 5626):** Radio buttons for 'Enabled' and 'Disabled', with 'Disabled' selected. Below is an informational icon: 'Enable this option to support best networking practices according to RFC 5626. This option should generally be enabled if the Algo device is being registered with a hosted server or if TLS is being used for SIP Transportation.'
 - Outbound Proxy:** An empty text input field.
 - Register Period (seconds):** A text input field containing '3600'.
- NAT:**
 - Media NAT:** Radio buttons for 'None', 'ICE', and 'STUN', with 'None' selected.
- Server Redundancy:**
 - Server Redundancy Feature (Multiple SIP Server Support):** Radio buttons for 'Enabled' and 'Disabled', with 'Disabled' selected.
- Interoperability:**
 - Keep-Alive Method:** Radio buttons for 'None' and 'Double CRLF', with 'None' selected. Below is an informational icon: 'This setting will enable sending periodic CRLF messages for both UDP and TCP connections.'
 - Use Outgoing TLS port in SIP headers:** Radio buttons for 'Enabled' and 'Disabled', with 'Enabled' selected. Below is an informational icon: 'Use ephemeral port number from outgoing SIP TLS connection instead of listening port number in SIP Contact and Via headers. This is useful to connect the device to some local SIP servers, like Asterisk or FreeSWITCH.'
 - Do Not Reuse Authorization Headers:** Radio buttons for 'Enabled' and 'Disabled', with 'Disabled' selected. Below is an informational icon: 'When enabled, all SIP authorization information from the last successful request will not be reused in the next request.'

A green 'Save' button with a checkmark is located at the bottom right of the settings area.

SIP Transportation

Which transport layer protocol to use for SIP messages. Setting 'SIP Transportation' to 'TLS', ensures the encryption of SIP traffic.

SIPS Scheme

Only visible when 'SIP Transportation' set to 'TLS'. Enabling SIPS Scheme requires the SIP connection from endpoint to endpoint to be secure.

SDP SRTP Offer

Setting 'SDP SRTP Offer' to 'Optional', means the SIP call's RTP data will be left unencrypted if the other party does not support SRTP. Setting 'SDP SRTP Offer' to 'Standard', encrypts RTP voice data, meaning the normal audio RTP packets will now be secure (SRTP). This means SIP calls will be rejected if other party does not support SRTP. The 'Standard' option secures the audio data between parties, by making sure that it's not left out in the open for third parties to later reconstruct and listen to.

SIP Outbound Support (RFC 5626)

Enable this option to support best networking practices according to RFC 5626. This option should generally be enabled if the Algo device is being registered with a hosted server or if TLS is being used for SIP Transportation.

Outbound Proxy

IP address for outbound proxy. A proxy (server) stands between a private network and the internet.

Register Period (seconds)

Maximum requested period of time where the 8180 SIP Audio Alerter (G2) will re-register with the SIP server. Default setting is 3600 seconds (1 hour). Only change if instructed otherwise.

Media NAT

IP address for STUN server if present or IP address/credentials for a TURN server.

Server Redundancy Feature

Two secondary SIP servers may be configured. The 8180 SIP Audio Alerter (G2) will attempt to register with the primary server but switch to a secondary server if necessary. The configuration allows re-registration to the primary server upon availability or to stay with a server until unresponsive.

Backup Server #1

Only visible if 'Server Redundancy Feature' is enabled. If primary server is unreachable the 8180 SIP Audio Alerter (G2) will attempt to register with the backup servers. If enabled, the 8180 will always attempt to register with the highest priority server.

Backup Server #2

Only visible if 'Server Redundancy Feature' is enabled. If backup server #1 is unreachable the 8180 SIP Audio Alerter (G2) will attempt to register with the 2nd backup server. If enabled, the 8180 will always attempt to register with the highest priority server.

Polling Intervals (seconds)

Only visible if 'Server Redundancy Feature' is enabled. Time period between sending monitoring packets to each server. Non-active servers are always polled, and active server may optionally be polled (see below).

Poll Active Server

Only visible if 'Server Redundancy Feature' is enabled. Explicitly poll current server to monitor availability. May also be handled automatically by other regular events, so can be disabled to reduce network traffic.

Automatic Failback

Only visible if 'Server Redundancy Feature' is enabled. Reconnect with higher priority server once available, even if backup connection is still fine.

Polling Method

Only visible if 'Server Redundancy Feature' is enabled. SIP message used to poll servers to monitor availability.

Keep-alive Method

If Double CRLF is selected the 8180 will periodically send a CRLF message for both UDP and TCP connections to maintain connection with the SIP Server.

Keep-alive Interval

Interval in seconds that the CRLF message should be sent.

Use Outgoing TLS port in SIP headers

Use ephemeral port number from outgoing SIP TLS connection instead of listening port number in SIP Contact and Via headers. This is useful to connect the device to some local SIP servers, like Asterisk or FreeSWITCH.

Do Not Reuse Authorization Headers

When enabled, all SIP authorization information from the last successful request will not be reused in the next request.

Advanced Settings Tab – Advanced Multicast

Advanced Multicast Settings

Current multicast mode: Slave
Multicast mode can be set in "Basic Settings > Multicast"

Slave Settings

Audio Sync (milliseconds, 0 ~ 1000)

When using multicast with other third-party devices that have a delay in their audio path, the audio on the 8180G2 may be heard slightly earlier than on these other devices. Use this feature to add a small delay to the audio output on the 8180G2 in order to synchronize with these other devices. Applies to Multicast Slave mode only.

Basic Zone Definition

If using an Algo device as a Multicast master, it is recommended to set the slave tones to "None" to avoid conflicts, as the Algo devices already multicast a tone by default.

Zone	IP Address and Port	Page Tone	Page Volume
Priority Call (DTMF:9)	224.0.2.60:50000	<None>	<Use Default Page Volume>
All Call (DTMF:0/8)	224.0.2.60:50001	<None>	<Use Default Page Volume>
Zone 1 (DTMF:1)	224.0.2.60:50002	<None>	<Use Default Page Volume>
Zone 2 (DTMF:2)	224.0.2.60:50003	<None>	<Use Default Page Volume>
Zone 3 (DTMF:3)	224.0.2.60:50004	<None>	<Use Default Page Volume>
Zone 4 (DTMF:4)	224.0.2.60:50005	<None>	<Use Default Page Volume>
Zone 5 (DTMF:5)	224.0.2.60:50006	<None>	<Use Default Page Volume>
Zone 6 (DTMF:6)	224.0.2.60:50007	<None>	<Use Default Page Volume>
Music (DTMF:7)	224.0.2.60:50008	<None>	<Use Default Page Volume>

Expanded Zone Definition

Zone	IP Address and Port	Page Tone	Page Volume
Zone 10 (DTMF: *10)	224.0.2.110:50000	<None>	<Use Default Page Volume>
Zone 11 (DTMF: *11)	224.0.2.111:50000	<None>	<Use Default Page Volume>

The default prepopulated multicast addresses above will work in most cases and should only be altered for rare cases.

Audio Sync (Slave Mode)

When using multicast with other third-party devices that have a delay in their audio path, the audio on the 8180 may be heard slightly earlier than on these other devices. By adding audio delay up to one second, the 8180 may be synchronized with other speakers or telephones that have greater latency. This feature applies to Multicast Slave mode only.

Master Output Codec (Master Mode)

Audio encoding format used by the Master device when sending output to the slaves.

Master Output Packetization Time (Master Mode)

The size of the audio packets sent by the Master to the Slaves. The default of 20ms is recommended, unless a different value is specifically required for compatibility with other devices.

RTCP Port Selection

Select the port on which RTCP packets will be sent or received. If using the 'Next Higher Port' option, ensure that the default multicast zone definitions are modified such that

zones are only assigned to even-numbered ports, leaving the next higher odd-numbered ports free for RTCP packets.

Zone Definition

The “Expanded” Slave or Master zones can be enabled/disabled in Basic Settings > Multicast. Default IP addresses and ports may be revised for any given zone in the table.



Important: Ensure that the Address and Port settings are the same for all master and slave devices.

Page Tone and Page Volume

Master Mode: By default, the same tone can be set for all Slave zones in the Basic Settings > Features tab. Unique paging tones may be revised for any given slave zone in the table above.

Slave Mode: When an Algo device is the multicast Master, a page tone will play on the Slave device, so it is recommended to set the Slave tone to “None”. If a page is received from a non-Algo device that doesn’t send a tone, a tone can be inserted on the Slaves (above) each time they detect page audio starting, allowing them to play a tone.

By default, the same page volume can be set for all Slave zones in the Basic Settings > Features tab. Unique page volumes may be revised on a per-zone basis in the table above. For instance, emergency pages can be louder on certain Slave speakers.

Polycom Slave Tones

Available if Multicast Slave and “Polycom Group Page” or “Polycom Push-to-Talk” are selected in the Basic Settings > Multicast tab. A tone may be set for any of the 25 Polycom Groups. If using an Algo device as a Multicast master, it is recommended to set the slave tones to “None” to avoid conflicts, as the Algo devices already multicast a tone by default.

Web Interface System

System Tab – Maintenance

Status Basic Settings Additional Features Advanced Settings **System** Logout

Maintenance System Log Credits About

System Maintenance

Backup / Restore Configuration

Download Configuration File

Restore Configuration File No file chosen

Restore Configuration to Defaults

Backup / Restore All User Files

Backup in zip format includes configuration file and all uploaded files.

Download Backup Zip File

Restore from Backup Zip File No file chosen

Restore All Settings and Files to Defaults

All preloaded and uploaded files, including tone files, will be deleted.

Reboot

Reboot the device

Upgrade to New Firmware

Method From Local Files From URL

Firmware Image No file chosen

MD5 Checksum No file chosen

Download Configuration File

Save the device settings to a text file for backup or to setup a provisioning configuration file.

Restore Configuration File

Restore settings from a backup file.

Restore Configuration to Defaults

Resets all 8180 SIP Audio Alerter (G2) device settings to factory default values.

Download Backup File

Saves the device settings (configuration) and all the files in File Manager: certificates, licenses, and tones to a backup zip file.

Restore from Backup Zip File

Restores the device settings (configuration) and all the files in File Manager: certificates, licenses, and tones from a backup zip file

Restore All Settings and Files to Defaults

Resets the device settings (configuration) and all the files in File Manager: certificates, licenses, and tones to factory default values.

Reboot the Device

Reboots the device.

Method

Specify whether the firmware files will be downloaded from the local computer or a remote URL.

Firmware Image

Point to the firmware image provided by Algo.

MD5 Checksum

Point to the checksum file provided by Algo.

How To Upgrade 8180 SIP Audio Alerter (G2) Firmware

1. From the top menu, click on System, then Maintenance.
2. In the Upgrade section, click on Choose File and select the 8180 speaker firmware file to upload. Note that both the FW firmware and MD5 checksum files must be loaded.
3. Click Upgrade
4. After the upgrade is complete, confirm that the firmware version has changed (refer to top right of Control Panel).

System Tab – System Log

System log files are automatically created and assist with troubleshooting in the event the 8180 SIP Audio Alerter (G2) does not behave as expected.

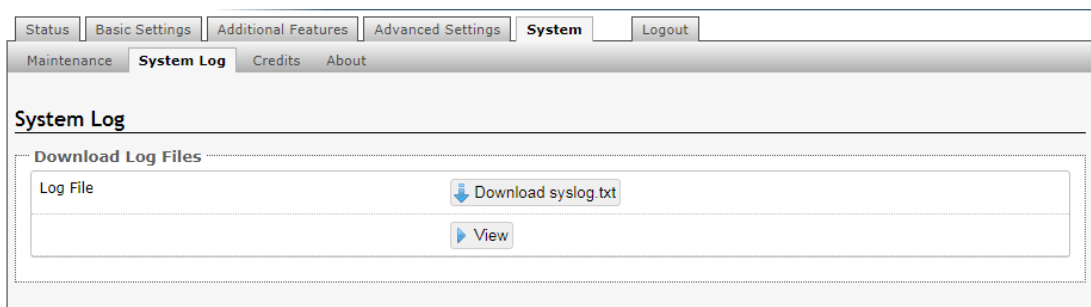

Wiring Connections

Network Connection

The speaker provides a RJ45 jack for network connection. A cable run from the switch can be terminated to a modular jack with connection by patch cord, or terminated with a RJ45 plug.

PoE (Power over Ethernet) must be 48V 350 mA IEEE 802.3af compliant whether provided by the network switch or injector.

There are two lights on the Ethernet jack:

Green light: On when Ethernet is working, flickers off to indicate activity on the port.

Amber light: Off when successful 100Mbps link is established. Typically On only briefly at power up.

Under normal conditions, the Amber light will turn on immediately after the Ethernet cable is first connected. This indicates that PoE power has been successfully applied. Once the device connects to the network, it will switch to the Green light instead, which will typically flicker indicating traffic on the network.

Connecting Input Devices

The dry contact relay on the 8180 SIP Audio Alerter (G2) can be prompted by any normally open, normally closed switch, Algo 1202 Call Button, Algo 1203 Call Switch, or Algo 1204 Volume Control Switch. The input switches can be connected to the back of the back of the 8180 via the “Dry Contact Relay” Terminal Block (terminals 5 & 6).

By default, the relay terminals (pins 5 & 6) are configured as an Output, set ‘Relay Terminal Function’ to ‘Input’ in **Additional Features > Relay Terminal Function** in order to reconfigure as an input.

The screenshot shows a web interface for configuring the device's input/output settings. The main heading is "Input/Output". Below it is a section titled "Terminal Block Functions". This section contains two rows of configuration options:

- Speaker Mode:** Includes radio buttons for "Auto", "Internal", "External", and "Disabled". A blue information icon is present next to the text: "Note that Auto mode is not available when the Relay Terminal Function is set to Input."
- Relay Terminal Function:** Includes radio buttons for "Output" and "Input". The "Input" option is currently selected.

Connection options can be configured from normally open switch, to normally closed switch, to Algo 1202 Call Button with large blue button, to Algo 1203 single gang backlit Call Switch, to Algo 1204 Volume Control Switch, or as an EOL resistor termination. The connection options can then be configured to complete an ‘Action’ when Relay Input is triggered.

General

Relay Input Mode

- Disabled
- Relay Normally Open
- Relay Normally Open with Supervision (e.g. Algo 1203 Call Switch)
- Relay Normally Closed
- Relay Normally Closed with Supervision
- Mute Switch
- Mute Switch with Supervision
- Algo 1202 Call Button
- Algo 1204 Volume Control Switch
- Algo 1204 Volume Control Switch with Supervision

Action When Input Triggered

Action

- Play Tone
- Make SIP Voice Call
- Make SIP Call with Tone
- Stream Mic Audio

ⓘ "Play Tone" will play a recorded audio file to a local speaker and multicast if configured. "Stream Mic Audio" will stream microphone audio to multicast only, so it requires Multicast "Master" mode to be enabled in "Basic Settings > Multicast".

Tone/Pre-recorded Announcement:

Tone Duration

- Play Once
- Play While Held

Note: See "Additional Features Tab – Input/Output" section of this user doc for additional information on input device configuration

Terminal Block (Relay Output Mode)

By default, these output terminals (Normally Open) are inactive. Outputs can be connected to the "Dry Contact Relay" Terminal Block (terminals 5 & 6), which provide contact closure when the 8180 SIP Audio Alerter (G2) is active from one of the following events: Ring, Page, Both, or disabled. The relay can trigger an external light or other device when specified event occurs.

Input/Output

Terminal Block Functions

Speaker Mode

- Auto
- Internal
- External
- Disabled

ⓘ Note that Auto mode is not available when the Relay Terminal Function is set to Input.

Relay Terminal Function

- Output
- Input

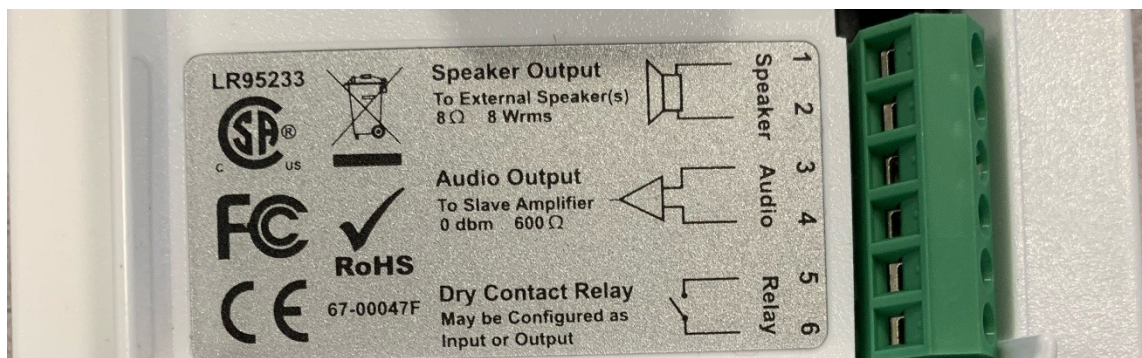

Blue LED Indicator

This LED light is on during initialization, boot, or while active. Ring and Page modes, when active, will turn the LED on steady. If the optional Talkback mode, 'Two-way', is enabled, under **Basic Settings > Page Mode**, the LED will now flash instead (during a page event)

to provide a clear indication that the microphone is active. The LED heartbeat option, when enabled, will flash the LED every 30 seconds as visual confirmation of PoE power and SIP server registration. LED configuration options can be found in **Additional Features > Input/Output**

Output	
Output Light	<input checked="" type="radio"/> Enabled <input type="radio"/> Disabled <small>ⓘ Disable the blue light on the speaker entirely (keep the light off even when the speaker is active)</small>
Heartbeat Light	<input type="radio"/> Enabled <input checked="" type="radio"/> Disabled <small>ⓘ Flash the blue light every 30 seconds to indicate that the speaker is powered and running.</small>
Output Relay	<input checked="" type="radio"/> Enabled <input type="radio"/> Disabled



Note: Option to change from Blue LED (default) to Red LED.

Specifications

Power Input:	48 V PoE IEEE 802.3af Class 0 (Max 12.95 W - Idle nominal 2W)
Weight:	1.15 lb (.52 kg)
SIP:	Multiple extensions for Page or Alerting
Multicast:	Receive or transmit
Sound Pressure Level:	106 dBA at 1m
Audio Codecs:	G.711 A-law, G.711 u-law, G.722, Polycom Group Page
Microphone:	Electret omnidirectional wideband
Audio Delay:	10 to 1000 ms selectable for synchronization
Audio Memory:	1 GByte available
Relay Output:	Normally open, activated when 8180 is in use Max 30 V 50 mA
Relay Input:	Normally open or normally closed dry contact, Algo 1202 CallBox, Algo 1203 Wall Switch, EOL termination

**Relay Input Current
Draw Detection
Thresholds:**

	Active	Idle	Tamper
Normally Open	>4mA	<4mA	N/A
Normally Open with Supervision	>20mA	4-20mA	<4mA
Normally Closed	<4mA	>4mA	N/A
Normally Closed with supervision	4-20mA	>20mA	<4mA

Nominal 12V source, current limited to 40mA
Typical supervision resistor value = 1k ohm

Configuration:	Web interface or provisioning
Provisioning:	TFTP, FTP, HTTP, HTTPS
Supervision:	SNMP

NAT:	STUN, CRLF Keep Alive
Processor:	Linux OS ARM Cortex-A8 32-Bit RISC Processor
Server Redundancy:	Primary, secondary, tertiary
Environmental:	32 to 104 °F (0 to + 40 °C); 10-95% RH non-condensing. Dry indoor locations only (Contact Algo for options for outdoor locations)
Compliance:	RoHS, CE, FCC Class A, CSA/UL (USA & Canada)

Dimensions

Front and Side

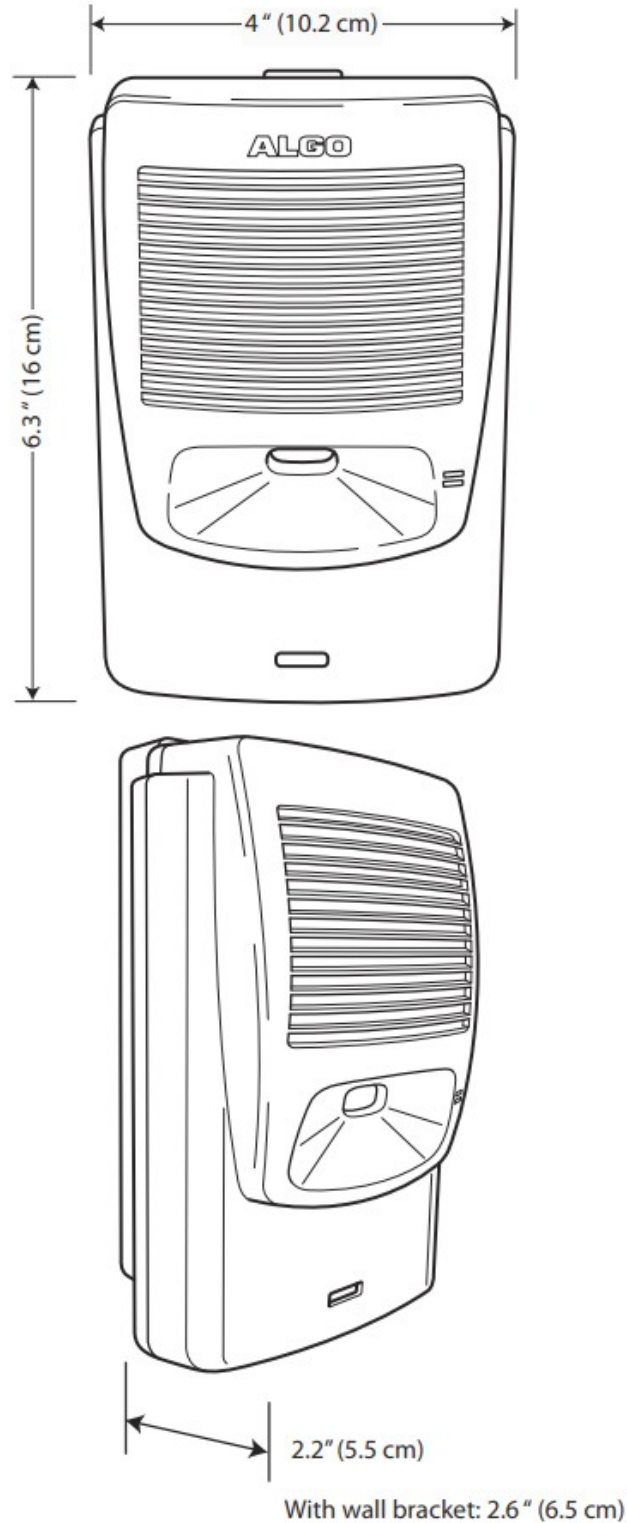

Wall Bracket

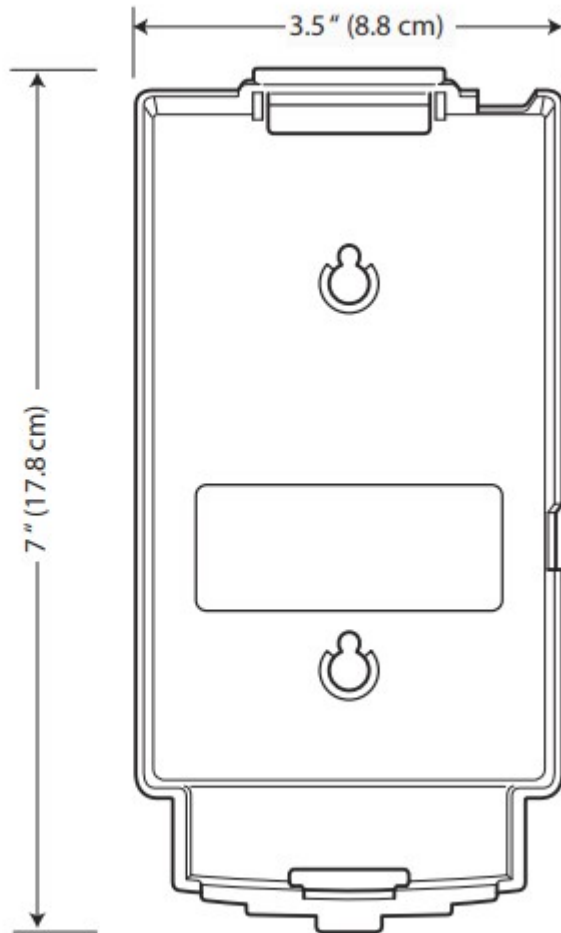

Optional 8180 Accessories

1186 Horn Speaker

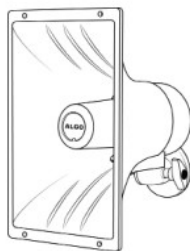

algosolutions.com/1186

1127 Visual Alerter

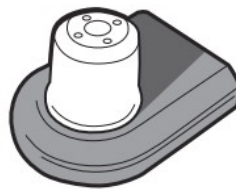

algosolutions.com/1127

1128 Strobe Light

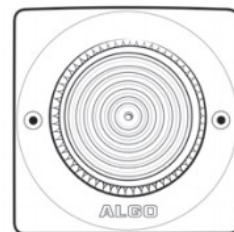

algosolutions.com/1128

FCC Compliance Statement

This equipment has been tested and found to comply with the limits for a Class A digital device, pursuant to Part 15 of the FCC Rules. These limits are designed to provide reasonable protection against harmful interference when the equipment is operated in a commercial environment. This equipment generates, uses, and can radiate radio frequency energy, and if it is not installed and used in accordance with the instruction manual, it may cause harmful interference to radio communications. Operation of this equipment in a residential area is likely to cause harmful interference, in which case the user will be required to correct the interference at his own expense.