

Telephone HT20

User Manual

JACOB JENSEN™



CONTENTS

The following items are included in the package of JACOB JENSEN™ Telephone HT20:

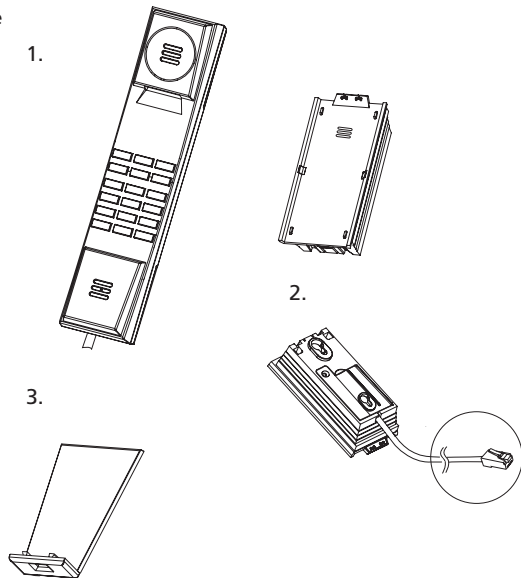
1. Telephone handset with coiled cord
2. Base station and line cord
3. Table stand



MAIN FEATURE LIST

- Hearing aid compatible handset
- Message button
- Redials the last number dialed and dialed number disappears within 5 minutes.
- Default 600ms hook switch flash. Can be set from 100ms to 1000ms according to the network specifications.
- Press  or  to adjust the handset volume
- PROG button – to programme the Message button
- Message and ringing Indicator
- Desktop and wall mounting

CONTROLS AND FUNCTIONAL KEYS

Handset

1. Customer logo printing area
2. 6 functional keys
3. 12 numerical keys
4. Message and ringing indicator

Base

5. Table stand
6. Base station
7. Handset cord jack

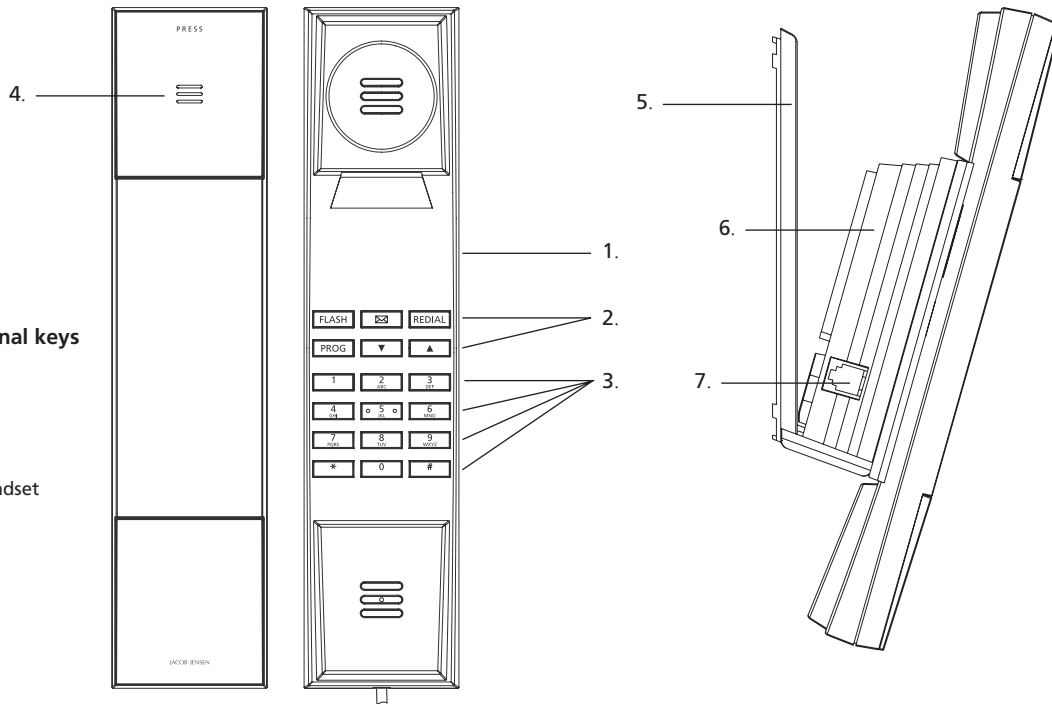

Features Description of the functional keys

FLASH	- Flash button
MESSAGE	- Message button
REDIAL	- Redial button
PROG	- For programming
▼ ▲	- To lower or increase the handset volume
✖	- Key for special services
#	- Key for special services

Congratulations on your new JACOB JENSEN™ Telephone HT20.

The telephone is designed in Denmark by Jacob Jensen, whose products have gained international recognition for their original, simple and classic design. Jacob Jensen has received about 100 prizes from around the world and has 19 products included in The Design Study Collection and The Design Collection of The Museum of Modern Art in New York.

A. INSTALLATION

A.1. Wall mounting

The distance between the two wall mounting holes is 55 mm. The holes are suitable for a 6 mm drill.

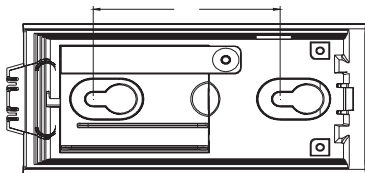

A.2. Base installation – table stand

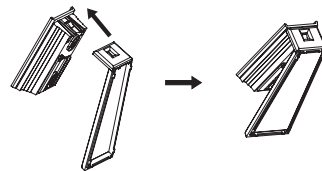

Disassembly:

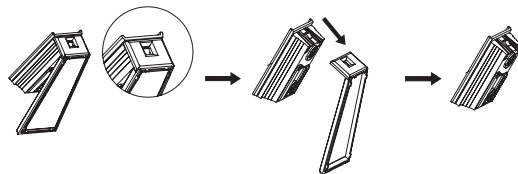

A.3. Connect the line cord to the wall socket

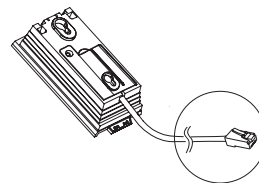

B. OPERATION

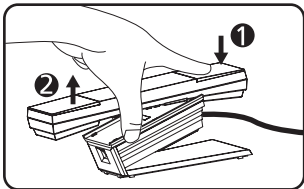



Receiving a call

Pick up the handset to answer the call.

Making a call

Pick up the handset to dial the desired number or press .





Adjust handset volume

Press the volume buttons   to lower or increase the volume of the handset. When you hang up, the volume will return to low level.

To redial the last number dialed

Press  key to dial the last number dialed. After five minutes the number will disappear automatically.

Programme the Message button

In off-hook mode, press  – press desired number and press , then press . In off-hook mode, press , the programmed number will be dialed.

Message Waiting Indicator (MWI)

It is compatible with high voltage neon/90V and Lucent low voltage system. Other MWI signalling systems must be confirmed by the factory and implemented in production.

The MWI will flash if there is a message. Please dial the telephone number for voice mail to retrieve the message.

The MWI is also a ringing indicator, which will flash if there is a call or a message.

C. MAINTENANCE

- Do not expose this product to dust, strong sunlight, humidity, high temperature, or mechanical shock.
- Do not use corrosive or abrasive cleansers on this product. Keep the unit dust free by wiping it with a soft, dry cloth.

D. TROUBLESHOOTING

1. **No dialing tone**
 - Check the telephone network
 - Check the connection of handset cord and straight line cord
2. **No ringing or no continuous ring**
 - Check the telephone line
 - Check the quantity of parallel phone set
 - Check flash settings
3. **Noise during talk**
 - Check the telephone line
 - Check the handset cord

E. FCC APPROVAL

Complies with Part 68 of the FCC rules. On the bottom of this telephone is a label that contains, among other information, the FCC registration number and the ringer equivalence number (REN) for this telephone. If requested, you must provide this information to the Telephone Company.

F. EC DECLARATION OF CONFORMITY

Hereby Bittel declares that this equipment (Telephone HT20, type JJ HT20) is in compliance with the essential requirements and other relevant provisions of Directive 2014/53/EU.



G. JACKS

Use RJ11C USOC standard modular jacks.

H. WARRANTY

This product is warranted for a period of 12 months from the date of purchase against faulty materials or workmanship. If during this period a defect arises, we may repair or replace the product, at Bittel's discretion, provided that:

1. The product has not been used for any purpose other than normal use.
2. Unauthorized product repair or modifications have not been attempted.
3. The product has never been used in a harsh or corrosive environment.
4. No damage in transit.

THIS LIMITED WARRANTY GIVES THE BUYER SPECIFIC LEGAL RIGHTS. THE BUYER MAY ALSO HAVE OTHER RIGHTS WHICH VARY FROM JURISDICTION TO JURISDICTION.

This warranty is only valid for merchandise purchased from the authorized dealers authorized by Bittel or the licence owner.

I. FCC WARNING

This device complies with part 15 of the FCC Rules. Operation is subject to the following two conditions: (1) This device may not cause harmful interference, and (2) this device must accept any interference received, including interference that may cause undesired operation.

J. CONTACT INFORMATION

Shandong Bittel Intelligent Technology Co., Ltd.

Telephone: (86) 633-2212119/2212113

Internet: www.bittelgroup.com

Email: <mailto:info@bittelgroup.com>

Address: **Shandong Bittel Intelligent Technology Co., Ltd.**

No. 1 Rizhao North Road, Rizhao,
Shandong, 276800, China

Service center North America:

Bittel Technology Inc.

1722 Little Orchard Street San Jose, California 95125 USA

Telephone: 1-888-9-BITTEL or 1-408-298-8206

Copyright © 2013 Bittel Inc. All rights reserved.

Produced in licence from:

Bell Xpress A/S

Telephone: (45) 70 22 60 33

Internet: www.bellxpress.dk

Email: mai@bellxpress.dk

Address: Sletvej 50
DK-8310 Tranbjerg J, Denmark

N. ENVIRONMENTAL CONCERNS AND DISPOSAL

Electric and electronic appliances and enclosed batteries contain materials, components and substances that can be damaging to people's health and to the environment, if the waste is not disposed of correctly.

Electric and electronic appliances and batteries are marked with a crossed-out wheellie bin symbol as illustrated below. It indicates that electric and electronic appliances and batteries are banned from being disposed of as general household waste, and have to be collected separately.

Please ask you dealer about current means of disposal.



- The contents of this manual are subject to change without notice.
- The manufacturer and its suppliers accept no liability whatsoever for any damage, expense, loss of profits or any other damage incurred as a result of using this product.

Product by: Bell Xpress A/S, Denmark · www.bellxpress.dk

www.jacobjensen.com



Generation to generation...