

# Telephone HT60

User Manual

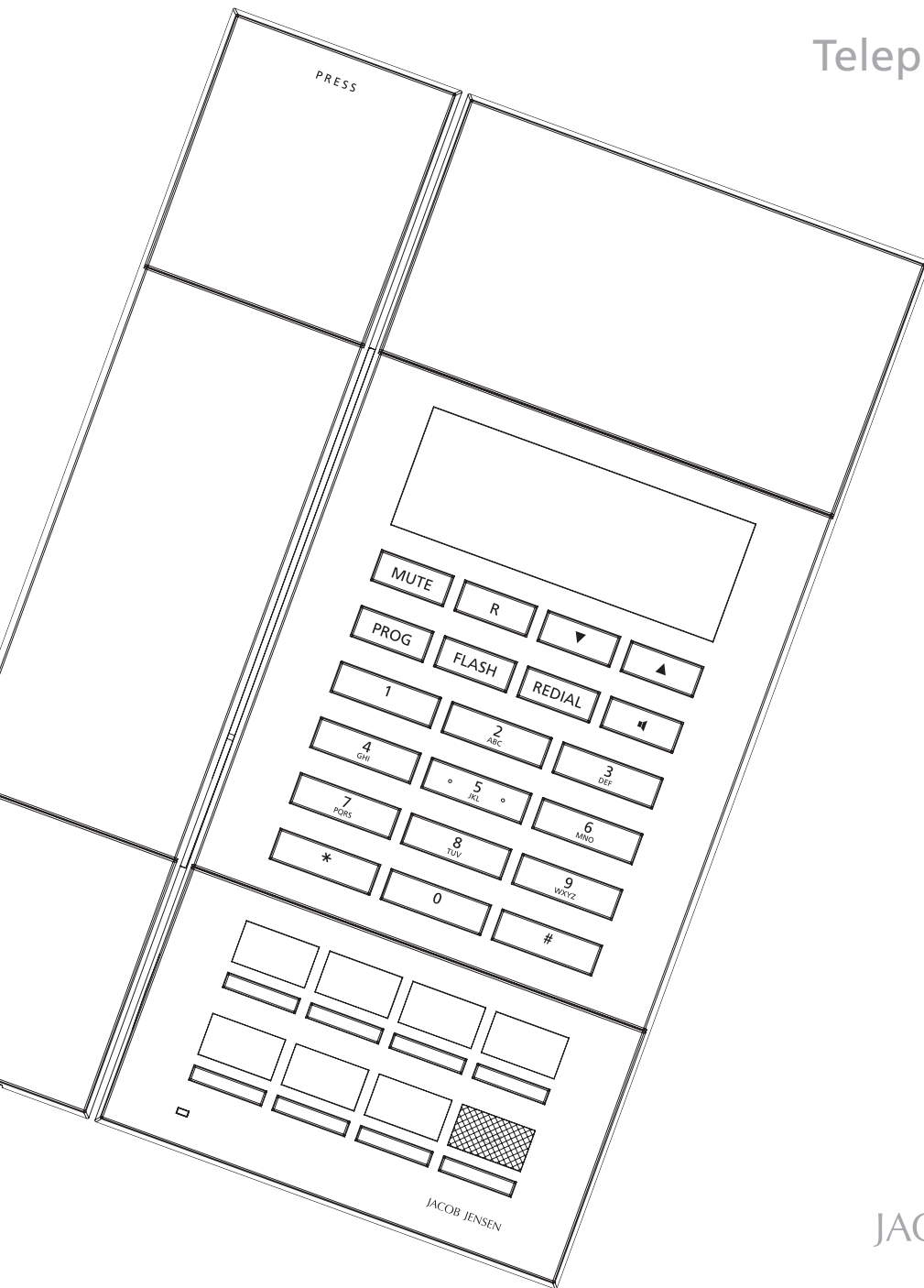

JACOB JENSEN™



## CONTENTS

The following items are included in the package of JACOB JENSEN™ Telephone HT60:

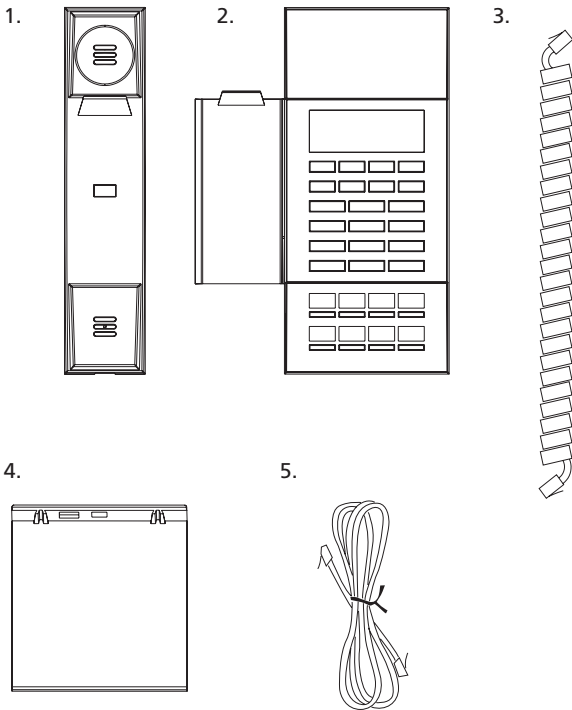
1. Telephone handset
2. Base station
3. Handset coiled cord
4. Table stand
5. Line cord



## MAIN FEATURE LIST

- Caller ID display, supports FSK and DTMF
- Caller ID number disappears after 30 seconds
- Hearing aid compatible handset
- Data port - for connecting MODEM, fax, etc.
- Service buttons - can be programmed and kept forever
- Volume buttons   to adjust the speaker and handset volume.
- **FLASH** - The default is 100ms. Can be set from 100ms to 600ms according to the network specifications.
- **REDIAL** button redials the last number dialled
- **PROG** button – programmes the service buttons
- **MUTE** button
- LED indicator for “Line in use (blue)” and “Mute (red)”
- **R** button – Signalling the PBX to activate the flash function. The default is 100ms.
- Speaker button with indicator
- Message waiting and ringing indicator
- Busy tone disconnects automatically
- Programme service button with R.P master cloner and handheld cloner.
- Pre-dial function (32 at most), which can be automatically dialled when you pick up the handset.
- Room number shown in display
- Desktop and wall mounting

## CONTROLS AND FUNCTIONAL KEYS

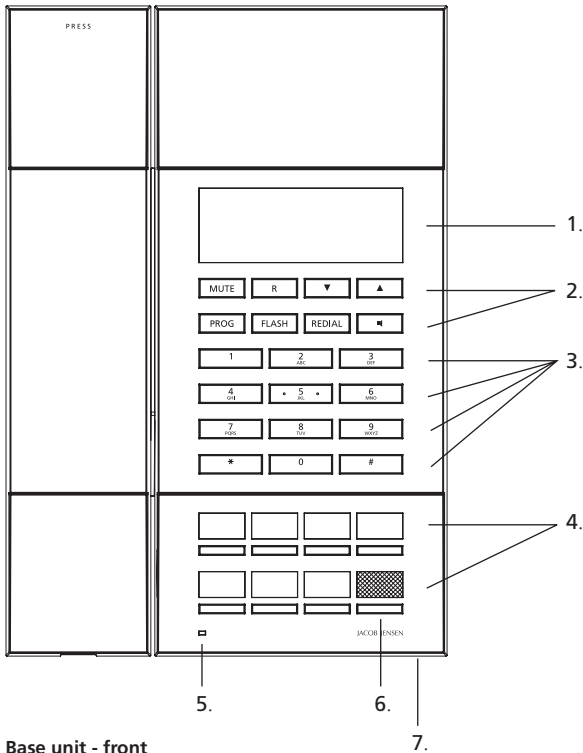

### Base unit - front

1. LCD screen display
2. 8 functional keys
3. 12 numerical keys
4. Service buttons
5. Indicator (LED) - for "Line in use (blue)" and "Mute (red)"
6. Message waiting indicator
7. Hands-free microphone

### Features Description of the functional keys

MUTE	- Microphone switch (handset)
R	- Signalling the PBX to activate the flash function The default is 100ms
▲ ▼	- To lower or increase the speaker and handset volume
PROG	- For programming
FLASH	- Flash button
REDIAL	- Redial button
☎	- For on hook dialling (speaker phone mode)
*	- Key for special services
#	- Key for special services

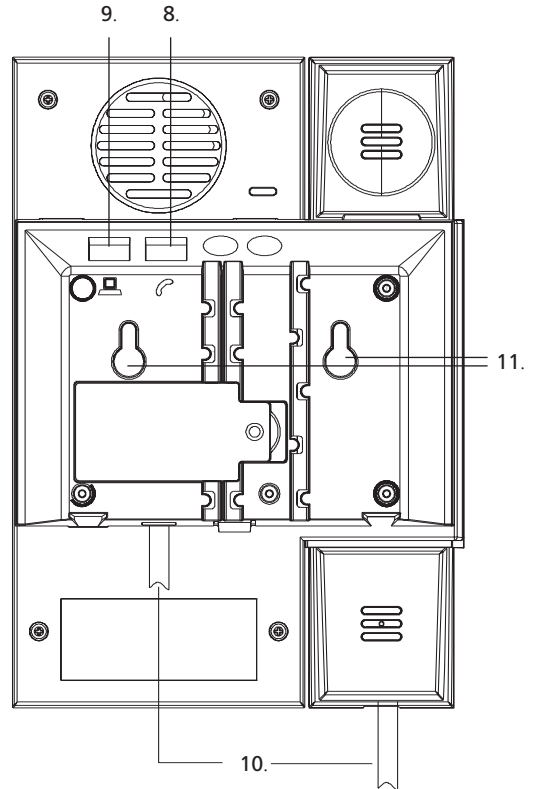

### Base unit - rear

8. Telephone line jack
9. Data port
10. Handset cord jack
11. Holes for wall mounting

Congratulations on your new JACOB JENSEN™ Telephone HT60.

The telephone is designed in Denmark by Jacob Jensen, whose products have gained international recognition for their original, simple and classic design. Jacob Jensen has received about 100 prizes from around the world and has 19 products included in The Design Study Collection and The Design Collection of The Museum of Modern Art in New York.

Telephone HT60 is a FSK/DTMF caller ID telephone. In order to activate this feature, please contact your telecoms service provider. Please read this guide before use and keep it handy for future reference.

## A. INSTALLATION

### A.1. Base installation – table stand

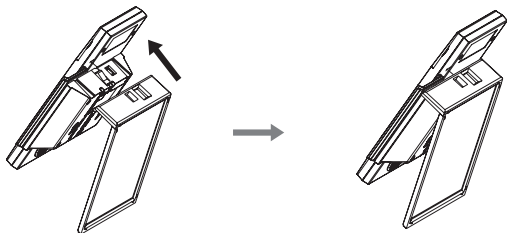

Disassembly:

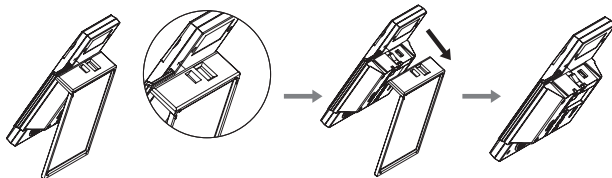

### A.2. Faceplate installation

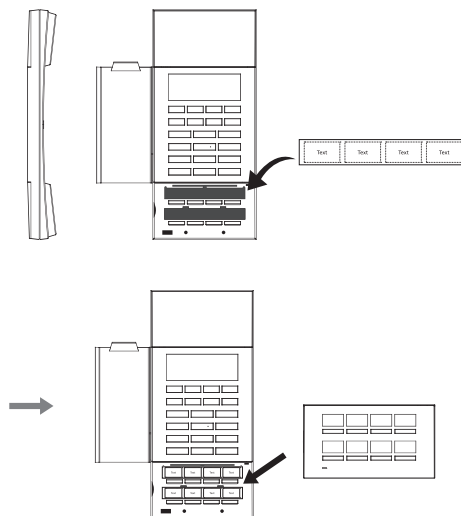

## B. HOW TO USE THE TELEPHONE



### Receiving a call

Pick up the handset or press .

### Making a call

Pick up the handset or press  – then dial the telephone number.

### Adjust speaker and handset volume

Press the volume buttons   to lower or increase the volume of speaker and handset. When you hang up, the volume of the handset will return to low level and the speaker volume will keep the current level.

### Handset and speaker phone mode exchangeable

1. From handset to speaker phone: Just press  and put the handset back to the cradle.
2. From speaker phone to handset : Just lift the handset.

### To redial the last number dialled

Press  to dial the last number dialled. After five minutes the number will disappear automatically.

## Mute Function

During the call, press **MUTE** once to stop the transmission for handset and speaker – the mute LED will light up. Press **MUTE** again to resume the call – the mute LED will turn off.

## Service buttons and MWI

1. To programme the service buttons or MWI: In on-hook mode, press **PROG** + programming number + **PROG** + Service button. If you need, you can insert **FLASH** or **R** button.  
In on-hook mode, press the relevant service button to see the programmed number.
2. In on-hook mode: Pick up the handset or press **☎**, then press the certain Service button, the programmed number will be dialled automatically.
3. To delete the programmed number: In on-hook mode, Press **PROG** + **PROG** + Service button or MWI. If you need, you can insert **FLASH** or **R**.

## Set room number

In off-hook mode, press **PROG** + room number + **PROG** + **▲** or **▼**. The room number will appear in the left side of the display.

In off-hook mode, pressing **\*13\*0987654321#** will delete all programmed numbers and the room number.

## Caller ID

When receiving caller ID information the telephone can recognize the format FSK & DTMF. This information will be stored automatically. If you need to change the format, you have to disconnect and re-power again.

The caller ID number will disappear within 30 seconds in order to protect guest's privacy. There are indicators for New call, Repeat call, Secret call, Message and so on. It can store 48 incoming calls. The displayed number is up to 16 digits.

If the format is FSK, the date and time will be auto updated. In DTMF mode, all settings won't be changed. Furthermore, the DTMF signal only includes incoming phone calls and doesn't include date and time.

## Setting Date and Time

In on-hook mode: Press **\*11\*** MMDDHHmm **#**.  
MM: month (01-12)  
DD: date (01-31)  
HH: hour (00-23)  
mm: minutes (00-59)

## Message Waiting Indicator (MWI)

It is compatible with high voltage neon/90V and Lucent low voltage system. Other MWI signalling systems must be confirmed by the factory and implemented in production. The MWI will flash if there is a message. Pick up the handset or press the speaker **☎**, then press the MWI to retrieve the message.

The MWI is also a ringing indicator, which will flash if there is a call or a message.

## Busy tone disconnect automatically

If the handset is not placed on the cradle after a phone call, the telephone can automatically switch to on-hook mode and the line will connect accordingly.

## Data port

The data port can be used to connect computer, fax, extension, etc.

## Programming the service buttons by Cloner

1. Enter actively Remote Programming Status : Off hook status, press **\*** for 5s of the base, the phone will send 3 dialing tones and the mute indicator flashes 3 times.
2. Escape actively Remote Programming Status: Off hook status, press **#** for 5s of the base, the phone will send 3 dialing tones and the mute indicator flashes 3 times

## Note:

- The phone will automatically escape the remote programming status if the phone is successfully programmed.
- Pressing the Volume button or back to on-hook status can stop the programming work.

### C. INSTALLATION ATTENTION & MAINTENANCE

The phone has been manufactured using the very latest technology and the highest quality components and workmanship, under ISO9001 quality control procedures. It can be relied on to provide many years of trouble-free service, especially if these simple tips are followed:

- Handle with care, avoiding hard knocks and shocks.
- Do not expose this product to dust, strong sunlight, humidity, high temperature, or mechanical shock.
- Do not use corrosive or abrasive cleansers on this product. Keep the unit dust free by wiping it with a soft, dry cloth.
- Do not tamper with or attempt to modify the phone, it would make it unsafe to use. Should any service difficulties or faults be encountered, the following list may help you identify and remedy problems. In many cases, however, it may be necessary to call the distributor from whom you purchased it.

### D. TROUBLESHOOTING

#### **1. No dialing tone**

- Check the telephone network
- Check the connection of handset cord and straight line cord

#### **2. No ringing or no continuous ring**

- Check the telephone line
- Check the quantity of parallel phone set

#### **3. Noise during talk**

- Check the telephone line
- Check the handset cord

### E. FCC APPROVAL

Complies with Part 68 of the FCC rules. On the bottom of this telephone is a label that contains, among other information, the FCC registration number and the ringer equivalence number (REN) for this telephone. If requested, you must provide this information to the Telephone Company.

### F. EC DECLARATION OF CONFORMITY

Hereby Bittel declares that this equipment (Telephone HT60, type JJ HT60) is in compliance with the essential requirements and other relevant provisions of Directive 2014/53/EU.



### G. JACKS

Use RJ11C USOC standard modular jacks.

### H. WARRANTY

This product is warranted for a period of 12 months from the date of purchase against faulty materials or workmanship. If during this period a defect arises, we may repair or replace the product, at Bittel's discretion, provided that:

1. The product has not been used for any purpose other than normal use.
2. Unauthorized product repair or modifications have not been attempted.
3. The product has never been used in a harsh or corrosive environment.
4. No damage in transit.

THIS LIMITED WARRANTY GIVES THE BUYER SPECIFIC LEGAL RIGHTS. THE BUYER MAY ALSO HAVE OTHER RIGHTS WHICH VARY FROM JURISDICTION TO JURISDICTION.

This warranty is only valid for merchandise purchased from the authorized dealers authorized by Bittel or the licence owner.

### I. FCC WARNING

This device complies with part 15 of the FCC Rules. Operation is subject to the following two conditions: (1) This device may not cause harmful interference, and (2) this device must accept any interference received, including interference that may cause undesired operation.

## J. CONTACT INFORMATION

### **Shandong Bittel Intelligent Technology Co., Ltd.**

Telephone: (86) 633-2212119/2212113

Internet: [www.bittelgroup.com](http://www.bittelgroup.com), [www.hotelphone.com](http://www.hotelphone.com)

Email: [info@bittelgroup.com](mailto:info@bittelgroup.com)

Address: **Shandong Bittel Intelligent Technology Co., Ltd.**  
No. 1 Rizhao North Road, Rizhao,  
Shandong, 276800, China

### **Service center North America:**

#### **Bittel Technology Inc.**

1722 Little Orchard Street San Jose, California 95125 USA

Telephone: 1-888-9-BITTEL or 1-408-298-8206

Copyright © 2013 Bittel Inc. All rights reserved.

Produced in licence from:

### **Bell Xpress A/S**

Telephone: (45) 70 22 60 33

Internet: [www.bellxpress.dk](http://www.bellxpress.dk)

Email: [mail@bellxpress.dk](mailto:mail@bellxpress.dk)

Address: Sletvej 50R  
DK-8310 Tranbjerg J, Denmark

## K. ENVIRONMENTAL CONCERNS AND DISPOSAL

Electric and electronic appliances contain materials, components and substances that can be damaging to people's health and to the environment, if the waste is not disposed of correctly.

Electric and electronic appliances are marked with a crossed-out wheellie bin symbol as illustrated below. It indicates that electric and electronic appliances are banned from being disposed of as general household waste, and have to be collected separately.

Please ask you dealer about current means of disposal.



- The contents of this manual are subject to change without notice.
- The manufacturer and its suppliers accept no liability whatsoever for any damage, expense, loss of profits or any other damage incurred as a result of using this product.

Product by: Bell Xpress A/S · [www.bellxpress.dk](http://www.bellxpress.dk)

[www.jacobjensen.com](http://www.jacobjensen.com)



Generation to generation...