



JACOB JENSEN for Hotels



About JACOB JENSEN DESIGN

The Scandinavian designer Jacob Jensen established his studio in 1958 and over the following decades created the revolutionary, pure and now classic form language which has made him one of the world's most recognised designers. Jacob Jensen has 19 products included in The Design Study Collection and The Design Collection of The Museum of Modern Art in New York.

Jacob Jensen's son Timothy Jacob Jensen has established the trademark JACOB JENSEN and clarified the universal potential of the form language by transferring it to many product groups. Bell Xpress has been an important player on this journey and has fathered the product line presented in this catalogue.

This catalogue shows the JACOB JENSEN™ Telephone Series. Equipped with various features the telephones have one thing in common: they are all very suitable for hotels. Further, the unique design completes the room refurbishing and adds "that little something" to the overall impression giving the guest an even more beautiful stay at your hotel.

About BITTEL

Shandong Bittel Intelligent Technology Co is a rapidly growing provider of innovative technology solutions for the global hospitality industry. Bittel products are known for their reliability and groundbreaking designs, and are installed in tens of thousands of hotels around the world. Headquartered in Rizhao, China, Bittel's North American operations are based in San Jose, California.



Selection of references

Rocco Forte, Edinburgh, UK
Six Senses Uluwatu, Bali, Indonesia
Jumeirah, Bali, Indonesia
Hotel Fontenay, Hamurg, Germany
QO Amsterdam by IHG, The Netherlands
Kimpton Amsterdam, The Netherlands
Mandarin Oriental, Doha, Qatar
M Gallery by Sofitel, Karkoy, Istanbul
Edition by Marriott, Barcelona, Spain
JW Marriott Seoul, South Korea
Marriott Chandris, Athens, Greece
Waldorf Astoria, Maldives
Claridges, London, UK
Browns, London, UK
Ritz Carlton Budapest Hungary
Steigenberger Hotel Maslak Istanbul, Turkey
Spice Hotel & spa Antalya, Turkey
AC Hotel Cambridge, MA, USA
Holiday Inn Express Karlsruhe
Swissotel the Bosphorus, Istanbul Turkey
Nikki Resort Bodrum, Turkey
Aqua Safari Hotel Ghana
Amano hotel Berlin Germany
KingFaisal Specialist - H-Complex
Marriott Hotel Berlin, Germany
Nikki Beach, UAE
Sansi Hotel, Leida Spain
Inglaterra Hotel Spain
InterContinental Bucharest Romania
Royal Hotel Seoul, Korea
AMAN Philippines

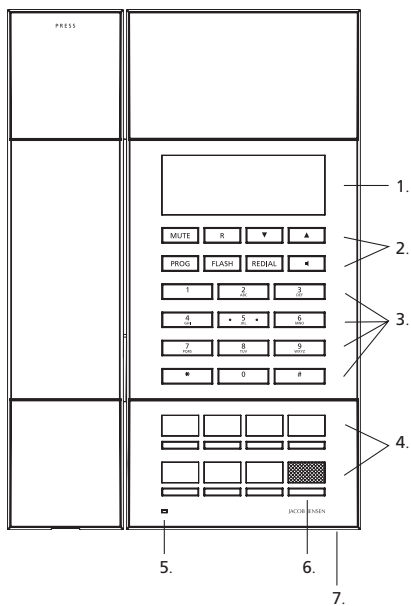

Base unit - front

1. LCD screen display
2. 8 functional keys
3. 12 numerical keys
4. Service buttons
5. Indicator (LED) - for "Mute (red)" and "Line in use (blue)"
6. Message waiting indicator
7. Hands-free microphone

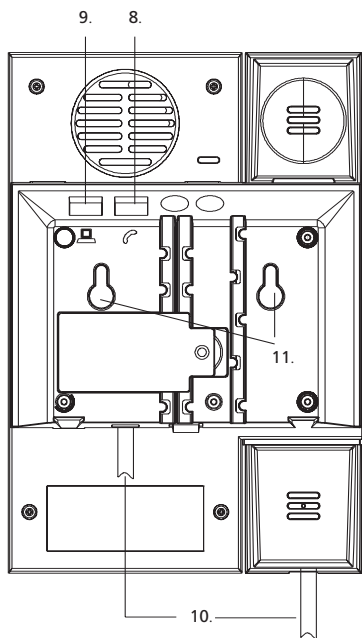

Base unit - rear

8. Telephone line jack
9. Data port
10. Handset cord jack
11. Holes for wall mounting



Colour scheme - front plates





Telephone HT60

Main Features

- Caller ID display, supports FSK and DTMF.
- Caller ID number disappears after 30 seconds.
- Hearing aid compatible handset.
- Data port - for connecting MODEM, fax, etc.
- Service buttons - can be programmed and kept forever.
- Volume buttons   to adjust the speaker and handset volume.
- FLASH - The default is 100ms. Can be set from 100ms to 600ms according to the network specifications.
- **REDIAL** button redials the last number dialled.
- **PROG** button – programmes the service buttons.
- **MUTE** button.
- LED indicator for “Line in use (blue)” and “Mute (red)”.
- **R** button – Signalling the PBX to activate the flash function. The default is 100ms.
- Speaker button with indicator.
- Message waiting and ringing indicator.
- Busy tone disconnects automatically.
- Programme service button with R.P master cloner and handheld cloner.
- Pre-dial function (32 at most), which can be automatically dialled when you pick up the handset.
- Room number shown in display.
- Desktop and wall mounting.
- Approved standards: EN 55022 and EN 55024.



Telephone HT60D

Main Features

- Corded base / cordless handset combination.
- Up to 4 handsets per base.
- Handset can be charged rapidly and give low power warning.
- Supports 1.8 / 1.9GHz, DECT 6.0 standards.
- Supports WDCT standard.
- Eight service keys can be customized to clients requirements.
- The volume can be adjusted in 5 levels.
- Message waiting lamp with retrieval function.
- Redial - Last number deleted after 5 minutes.
- Hold, Mute, Flash.
- Desktop and wall mounting.
- Approved standards: EN 55022 and EN 55024.





Telephone HT20D

Main Features

- Cordless handset and base station.
- Supports 1.8 / 1.9GHz, DECT 6.0 standards.
- Supports WDCT standard.
- Up to four handsets per base.
- Three service keys.
- Message waiting Indicator.
- The volume can be adjusted in 5 levels.
- Speakerphone.
- Low battery indicator.
- Redial - Last number deleted after 5 minutes.
- Ultra Slim Handset
- Mute, Hold
- Desktop and wall mounting.



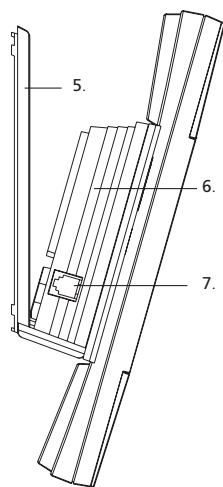
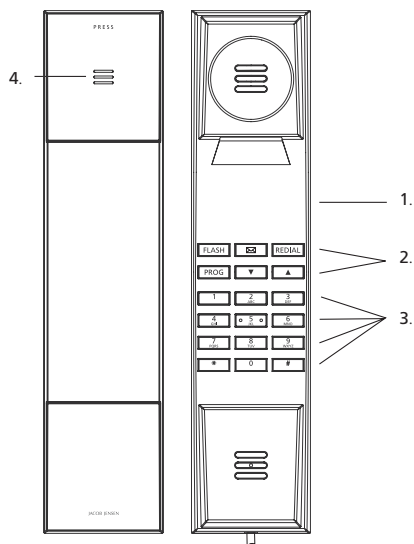

Handset

1. Customer logo printing area
2. 6 functional keys
3. 12 numerical keys
4. Message and ringing indicator

Base

5. Table stand
6. Base station
7. Handset cord jack

Colour scheme - front plates





Telephone HT20

Main Features

- Hearing aid compatible handset.
- Message button.
- Redials the last number dialled – dialled number disappears within 5 minutes.
- Default 600ms hook switch flash. Can be set from 100ms to 1000ms.
- Adjustable handset volume.
- PROG button.
- Message and Ringing Indicator.
- Desktop and wall mounting.
- Approved standards: EN 55022 and EN 55024.





Telephone HT60DU

Main Features

- DECT handset on base with numeric keypad
- Up to 4 DECT handsets can be register to each base.
- Full duplex speakerphone on base
- Pairs with HS20 handset
- 8 guest service keys
- 3 guest service keys on handset
- Mute, flash, speaker, hold, redial
- Redial deleted after 5 minutes
- Fast charging and low battery indication on handset.
- Message waiting lamp key with retrieval function.
- Adjustable earpiece / speaker volume / ringer volume.
- Desk or wall mountable.
- DECT 6.0 technology for clear sound.
- Premium adhesive custom faceplates.
- Approved standards: EN 55022 and EN 55024.
- Colour options





Telephone IP60DU

Main Features

- DECT handset on base, VOIP and SIP compatible.
- Up to 4 cordless handsets can be registered to each base
- Full duplex speakerphone on base
- Pairs with HS20 handset
- 8 guest service keys
- 3 guest service keys on cordless handset
- Mute, flash, speaker, hold, redial
- Redial deleted after 5 minutes
- Fast charging and low battery warning on handset.
- Message waiting lamp key with retrieval function.
- Adjustable earpiece / speaker volume / ringer volume
- Desk or wall mountable
- Easy web configuration
- IP address via DHCP / Static IP
- PCMU, G.723.1, G.729a/b, PCMA speech
- IEEE802.1 Q standard, IEEE802.3af protocol
- Cloud configuration
- Integrated POE power supply for easy integration







Telephone IP60D with Cordless Handset HS20D

Main Features

- Corded Handset with Integral DECT base station VOIP, SIP compatible.
- Calls can be made and received from the base or the cordless handset. Up to 4 cordless handsets can be registered to each base.
- Supports 1.8/1.9GHz, DECT6.0, WDCT standards.
- Fast charging and low battery warning on cordless handset.
- Mute, Flash, Speaker, Hold, Redial.
- Redial deleted after ten minutes.
- Adjustable earpiece / speaker volume / ringer volume.
- Speakerphone.
- Easy web configuration.
- Desk or wall mountable.
- Supports message waiting lamp key with retrieval function.
- 8 Service buttons with icon.
- Supports obtaining IP address via DHCP/Static IP.
- Supports PCMU, G.723.1, G.729a/b, PCMA speech decoding algorithms.
- Supports RFC2833, SIP INFO, and other DTMF transmission mode.
- Supports IEEE802.1 Q standard, IEEE802.3af protocol.
- Supports SIP protocol's standards.
- Supports upgrade through HTTP/TFTP protocol.
- Adopts dynamic speech detection; Comfortable noise generation; Speech buffering technologies.
- Integrated PoE power supply function for easy installation.
- Approved standards: EN 55022 and EN 55024.

Cordless Handset HS20D

Main Features

- Ultra Slim Handset
- Hands free on handset
- Voice message Waiting Indicator
- 3 service keys
- Speakerphone
- Low battery indicator
- Indoor range 50 m
- Outdoor range 300 m
- Up to 4 handsets per base
- Desk or wall mountable
- Approved standards EN 55022 and EN 55024



Telephone IP60D

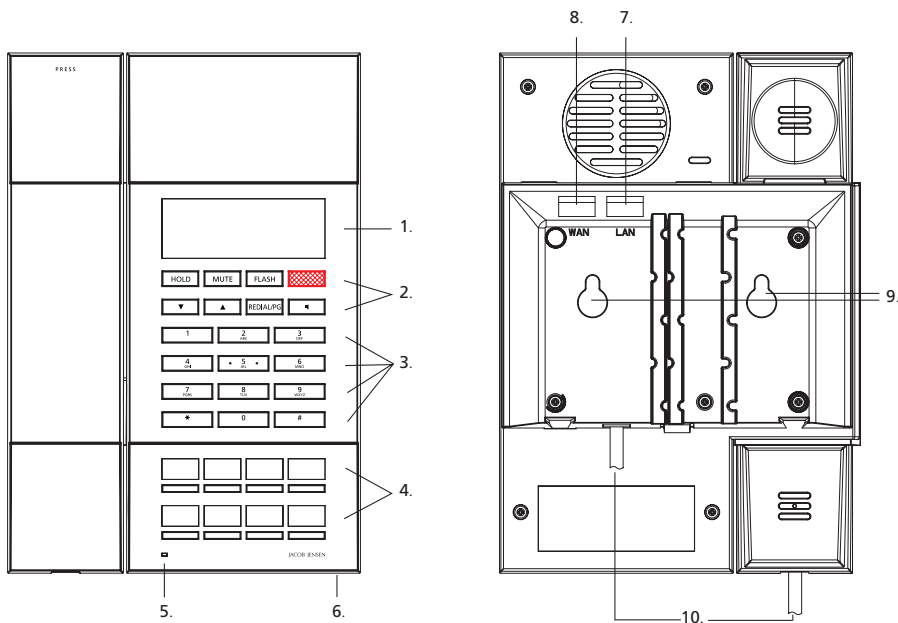

Base unit - front

1. Customer label area
2. 8 functional keys
3. 12 numerical keys
4. Service buttons
5. Indicator (LED) - for "Mute (red)" and "Line in use (blue)"
6. Hands-free microphone

Base unit - rear

7. LAN port
8. WAN port
9. Holes for wall mounting
10. Handset cord jack

Colour scheme - front plates



Cordless Handset HS20D

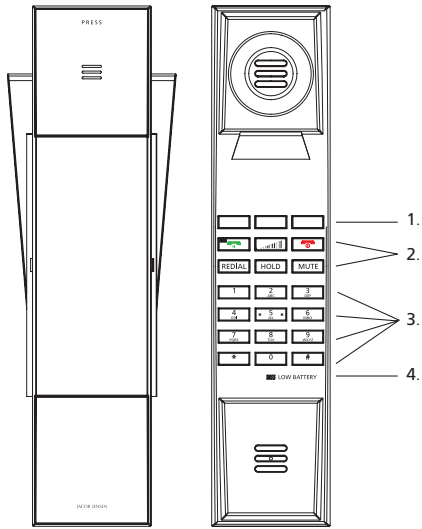

Handset

1. Service buttons
2. 6 functional keys
3. 12 numerical keys
4. Indicator for low voltage

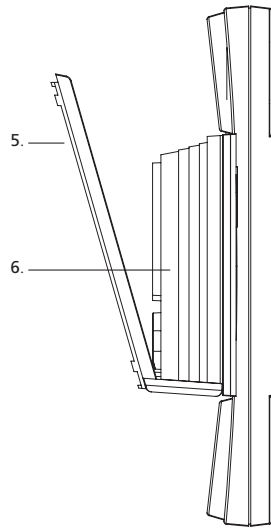

Base

5. Table stand
6. Base station

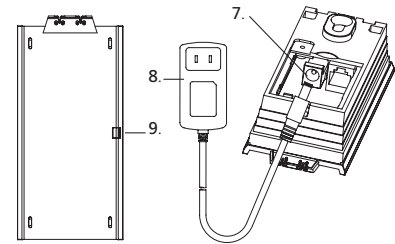

Base unit - rear

7. Power jack
8. Adapter
9. Charge indicator

Colour scheme - front plates



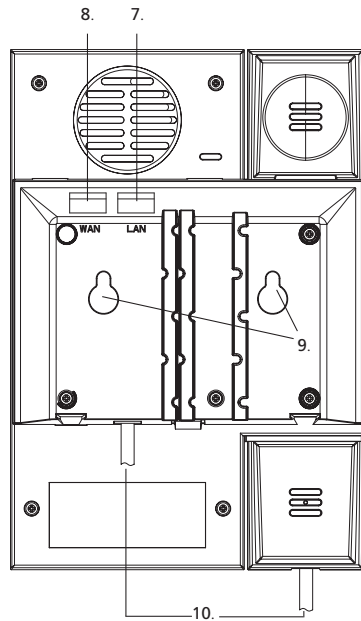
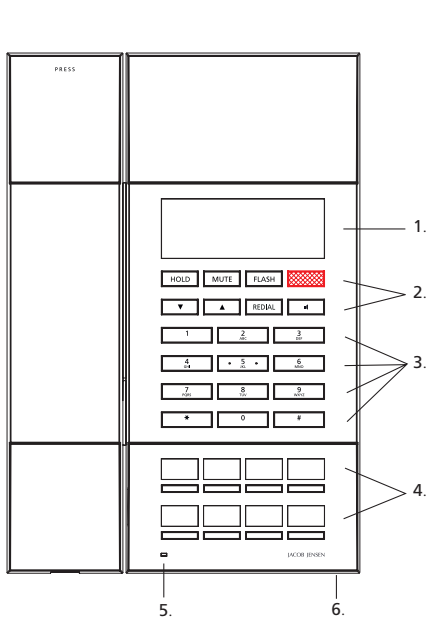

Base unit - front

1. Customer label area
2. 8 functional keys
3. 12 numerical keys
4. Service buttons
5. Indicator (LED) - for "Mute (red)" and "Line in use (blue)"
6. Hands-free microphone

Base unit - rear

7. LAN port
8. WAN port
9. Holes for wall mounting
10. Handset cord jack

Colour scheme - front plates

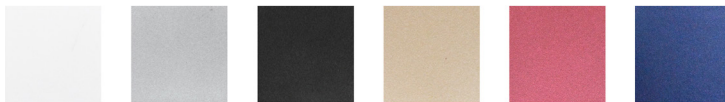



Telephone IP60N

Main Features

- Corded Handset VOIP and SIP compatible.
- Mute, Flash, Speaker, Hold, Redial.
- Redial deleted after ten minutes.
- Adjustable earpiece / speaker volume / ringer volume.
- Speakerphone.
- Easy web configuration.
- Desktop or wall mounting.
- Supports message waiting lamp key with retrieval function.
- 8 Service buttons with icon.
- Supports obtaining IP address via DHCP/ Static IP.
- Supports PCMU, G.723.1, G.729a/b, PCMA speech decoding algorithms.
- Supports RFC2833, SIP INFO, and other DTMF transmission mode.
- Supports IEEE802.1 Q standard, IEEE802.3af protocol.
- Supports SIP protocol's standards.
- Supports upgrade through HTTP/TFTP protocol.
- Adopts dynamic speech detection; Comfortable noise generation; Speech buffering technologies.
- Integrated PoE power supply function for easy installation.
- Approved standards: EN 55022 and EN 55024.



Telephone IP60

Main Features

- Corded Handset, VOIP and SIP compatible.
- Caller ID Alphanumeric Display.
- Two accounts
- Four programmable guest service keys.
- Message waiting lamp key with retrieval function.
- High quality speakerphone.
- Built in 2.4G WiFi
- Supports DHCP (dynamic host configuration protocol) and static IP address protocol for getting IP address.
- Supports PCMU, G.723.1,G.729a/b,PCMA speech decoding algorithms.
- Supports RFC2833, SIP INFO, and other DTMF transmission mode.
- Supports IEEE802.1 Q standard, IEEE802.3 as standard.
- Upgrade through HTTP/TFTP protocol.
- Integrated Poe power supply and easy for installation.
- Desktop and wall mounting.
- Approved standards: EN 55022 and EN 55024.





Telephone IP20D

Main Features

- Cordless Handset, VOIP and SIP compatible.
- IP DECT base contained in separate box for flexible installation.
- Up to four handsets per base.
- Supports 1.8 / 1.9GHz, DECT 6.0 standards.
- Supports WDCT standard.
- Three programmable service keys.
- Supports message waiting lamp key with retrieval function.
- The volume can be adjusted in 5 levels.
- Supports DHCP (dynamic host configuration protocol) and static IP address protocol for getting IP address.
- Supports PCMU, G.723.1, G.729a/b, PCMA speech decoding algorithms.
- Supports RFC2833, SIP INF, and other DTMF transmission mode.
- Supports IEEE802.1 Q standard, IEEE802.3 as standard.
- Supports updating the program by HTTP.
- Dynamic voice detection; Voice polishing; Voice buffering.
- Integrated PoE power supply and easy for installation.
- Desktop and wall mounting.
- Approved standards: EN 55022 and EN 55024.



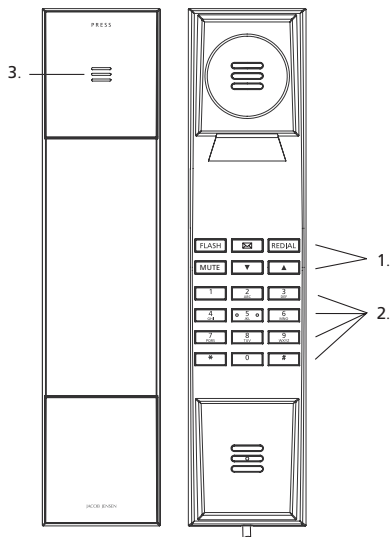

Handset

- 1. 6 functional keys
- 2. 12 numerical keys
- 3. Message and ringing indicator

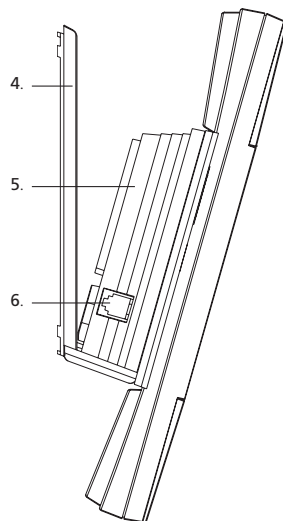

Base

- 4. Table stand
- 5. Base station
- 6. Handset cord jack

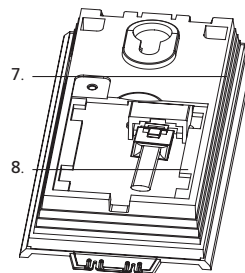

Base – rear

- 7. WAN Jack
- 8. Ethernet Cable

Colour scheme - front plates





Telephone IP20

Main Features

- Mute, Flash and Redial function.
- Supports message waiting lamp key with retrieval function.
- The volume can be adjusted in 5 levels.
- Supports DHCP (dynamic host configuration protocol) and static IP address protocol for getting IP address.
- Supports PCMU, G.723.1,G.729a/b,PCMA speech decoding algorithms.
- Supports RFC2833, SIP INF, and other DTMF transmission mode.
- Supports IEEE802.1 Q standard, IEEE802.3 as standard.
- Supports SIP protocol's standards.
- Supports updating the program by HTTP.
- Dynamic voice detection; Voice polishing; Voice buffering.
- Integrated Poe power supply and easy for installation.
- Desktop and wall mounting.
- Approved standards: EN 55022 and EN 55024.





Shandong Bittel Intelligent Technology Co., Ltd.

Add: NO. 1 Rizhao North Road, Rizhao, Shandong, China 276800

TEL: 0086-633-2212160 FAX:+86-633-2212118 E-mail: info@bittelgroup.com www.bittelgroup.com